

# **PNEUMATIC CONVEYING & INDUSTRIAL VACUUM COMPONENTS**

**TUBING, BENDS, COUPLINGS, & FITTINGS**



**H-P Products**

**A HIGH-PERFORMANCE COMPANY**

H-P Products is certified to ISO 9001:2015

# TABLE OF CONTENTS

---

Bending Capabilities  
Standard Tubing  
Tube Bends  
Tube Fittings

---

Bending Capabilities  
Standard Tubing  
Standard Radius Elbows  
Standard Long Radius Bends  
Valves

---

Standard Pipe  
Pipe Bends  
Pipe Fittings

---

Standard 90° TY's  
Standard 45° YL's  
Standard Double Y's  
Standard Reducing Couplings  
Standard Adapters

---

Instalok™ Couplings  
Compression Couplings  
Eliminators  
Eliminator Kits  
Super Grips  
Cam & Groove Couplings

---

Slip Couplings  
Shrink Sleeves  
Instalok™ Couplings  
Compression Couplings  
Slip Welding Rings  
Tube Hangers, Plugs, Nipples

---

Vacuum Wands, Sight Glasses,  
Hoses & Clamps  
Installation Components  
Requesting Special  
Fabrication

---

Shot Peening  
Porcelain Lining  
Ceramic Coating  
Part Variations

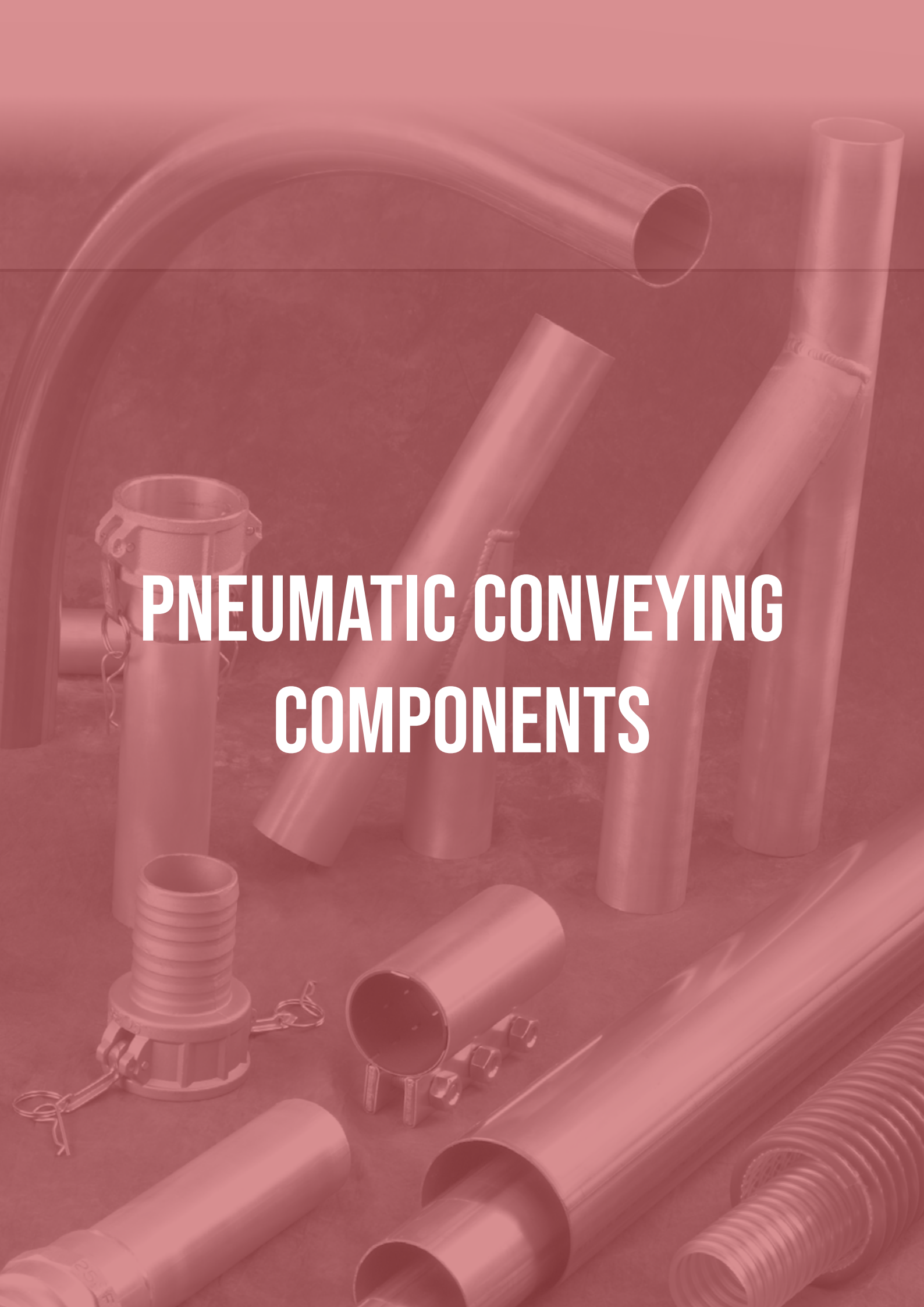

# PNEUMATIC CONVEYING COMPONENTS

# PNEUMATIC CONVEYING PRODUCTS

H-P Products specializes in supplying pneumatic conveying components for a variety of material handling applications.

H-P's commitment to superior customer service is strengthened by new product developments such as the Instalok Coupling and improved ordering and fulfillment systems. Our commitment to continual improvement has established H-P as a leader in the pneumatic conveying industry.

Our mission is simple: provide superior products and deliver customer service that consistently yields on-time delivery allowing our customers to be successful and more competitive in their markets.

We're looking forward to your next order!

Sincerely,  
**The Customer Service Team at H-P**

## PRODUCTS

---

### TUBE & PIPE

Our tubing ranges from 1-1/2" through 10" OD in 11, 12, 14 and 16 gauge wall thickness. We also have the capability of supplying tube up to 14" OD.

Standard pipe is available in schedule 5, 10, 40, and 80 wall thickness, and ranges from 1" through 8" NPS.

Both tube and pipe are available in Carbon, Stainless Steel, Aluminum, and Galvanized Steel. Standard lengths are 20' but we can cut to your specifications.

### BENDS & BENDING CAPABILITIES

Our inventories include a wide range of parts: **Short Radius** (1-1/2 times OD / NPS), **Standard Radius** (2-1/2 times OD / NPS) and **Long Radius Bends** (up through 60" center line). Available in **Carbon, Stainless Steel and Aluminum**.

Zinc-Coated (Galvanized) bends are available upon request.

### FITTINGS

We offer a wide variety of laterals, wyes, tees, adapters, and flanges for connecting both pipe and tube. Available in Carbon, Stainless Steel, and Aluminum.

### METHODS OF JOINING

The INSTALOK™ Coupling, developed for the plastics industry, is available in 1-1/2" through 4" OD for tube and 2" through 3-1/2" NPS for pipe. This coupling reduces installation time and provides superior grip strength and end pull.

The Compression Coupling is available in 1-1/2" through 14" OD and 1-1/4" through 12" NPS in pipe. The G-90 Galvanized Exterior Coating provides superior corrosion resistance.

We also offer a wide variety of gaskets, eliminators, super grips, cam and groove components.

### ACCESSORIES

H-P Products offers an extensive selection of the accessories you need to complete your system. We carry everything from you need from vacuum wands, sight glasses to hose and installation components.

## NEED SOMETHING SPECIAL?

Our sales engineers will assist you in working out a cost-effective solution...Simply give us a call!

# TUBE DIMENSIONS & BENDING

All reference dimensions are nominal

## TUBING

Our standard catalog tube sizes range from 1-1/2" through 10" OD in Carbon, Stainless Steel, and Aluminum. Please ask about our additional bending & fabricating capabilities in tubing sizes up through 14"OD.

Zinc-Coated (Galvanized) tubing and bends are available as a special order.

## TUBE DIMENSIONS

WALL THICKNESS	INCHES
16 Gauge	.065
14 Gauge	.083
12 Gauge	.109
11 Gauge	.120

OD (IN.)	CENTER LINE RADIUS (IN.)	GAUGE
1-1/2	1-3/4, 2-1/2, 3, 4, 6, 7-1/2, 9, 12, 15, 18, 24, 30, 36	11, 14, 16, 18
1-5/8	2-1/8, 2-1/2	16
1-3/4	2-1/2, 3, 4, 4-1/2, 6, 8, 9, 12, 15, 24, 30, 36	11, 14, 16
2	2, 2-1/2, 3, 3-1/2, 4, 5, 6, 8, 9, 10, 12, 15, 18, 24,30, 36, 48	11, 14, 16
2-1/8	2-7/8, 3-1/2, 5, 12, 20, 24, 36	11, 16
2-1/4	2-1/2, 3, 4, 5-1/2, 8, 9, 12, 15, 18, 24, 30, 36, 42	11, 14, 16, 18
2-3/8	2-3/8, 3, 6, 8, 12, 18, 24, 30, 36, 48	16, 18
2-1/2	2-1/2, 3, 3-1/4, 3-3/4, 4, 5, 6, 9, 12, 15, 18, 24, 30, 36, 48	11, 14, 16
2-3/4	2-3/4, 3-7/8, 15, 24, 30	11, 14, 16, 18
2-7/8	3-3/4, 9, 10, 12, 24, 30, 36, 48, 60	11, 14, 16
3	3, 4, 4-1/2, 6, 7-1/2, 9, 12, 15, 18, 24, 30, 36, 38, 48, 60	11, 14, 16, 18
3-1/2	3-1/2, 4, 4-1/2, 5, 6, 7-1/2, 8, 8-3/4, 12, 13, 15, 18, 24,11, 14, 16, 18 ,30, 36, 48, 60	11, 14, 16, 18
4	4, 6, 8, 9, 10, 12, 18, 24, 30, 36, 48, 60	11, 14, 16, 18
4-1/2	6, 9, 12, 16, 20, 24, 30, 36, 48, 60	11, 14, 16
5	5, 5-1/2, 7-1/2, 12-1/2, 18, 24, 30, 36, 48, 60	11, 14, 16
6	7, 9, 15, 24, 30, 36, 48, 60	11, 14, 16
8	12, 20, 32, 48	11, 14

**COMPLETE TUBE  
BENDING CAPABILITIES**

PLEASE CONTACT H-P REGARDING SPECIAL MATERIALS, GAUGE & RADII

Catalog Part Variations Available Upon Request

**GIVE US A CALL IF YOU CAN'T FIND EXACTLY WHAT YOU NEED!**

# PIPE DIMENSIONS & BENDING

©2024 H-P Products

## PIPE

We offer standard pipe sizes from 1" to 8" NPS in Aluminum, Carbon and Stainless Steel.

### PIPE DIMENSIONS

NPS (INCHES)	OD (INCHES)	SCH 5	SCH 10	SCH 40	SCH 80
1"	1.315	.065	.109	.133	.179
1-1/4"	1.660	.065	.109	.140	.191
1-1/2"	1.900	.065	.109	.145	.200
2"	2.375	.065	.109	.154	.218
2-1/2"	2.875	.083	.120	.203	.276
3"	3.500	.083	.120	.216	.300
3-1/2"	4.000	.083	.120	.226	.318
4"	4.500	.083	.120	.237	.337
5"	5.563	.109	.134	.258	.375
6"	6.625	.109	.134	.280	.432
8"	8.625	.109	.148	.322	.500

### PIPE BENDING CAPABILITIES

NPS (INCHES)	OD (INCHES)	CENTER LINE RADIUS (INCHES)	SCHEDULE (INCHES)				
			5	10	40	80	OTHER
1-1/2	1.900	6, 9, 12, 18, 36	-	-	.145	.200	-
2	2.375	2-3/8, 3, 6, 8, 12, 18, 24, 30, 36, 48	.065	.109	.154	.218	-
2-1/2	2.875	3-3/4, 9, 10, 12, 24, 30, 36, 48, 60	.083	.120	.203	.276	-
3	3.500	4, 4-1/2, 5, 6, 7-1/2, 8, 8-3/4, 12, 13, 15, 18, 24, 30, 36, 48, 60	.083	.120	.216	.300	.188
3-1/2	4.000	4, 6, 8, 9, 10, 12, 18, 24, 30, 36, 48, 60	.083	.120	-	.300	-
4	4.500	6, 9, 12, 16, 20, 24, 30, 36, 48, 60	.083	.120	.237	.337	.188
5	5.563	24, 30, 36, 48, 60	-	.134	.258	.375	-
6	6.625	24	-	.134	.280	-	.188, .250
8	8.625	32	-	.148	.322	-	.188, .250

#### TERMINOLOGY

CLR	Center Line Radius
ERW	Electric Resistance Welded
FNPT	Female National Pipe Thread
ID	Inside Diameter
MNPT	Male National Pipe Thread
NPS	Nominal Pipe Size
OD	Outside Diameter
SCH	Schedule

# TUBING

All reference dimensions are nominal

## ALUMINUM

OD (IN.)	GAUGE	PRODUCT ID
1-1/2"	16	16ST150A
1-1/2"	14	14ST150A
1-1/2"	11	11ST150A
1-3/4"	16	16ST175A
1-3/4"	14	14ST175A
1-3/4"	11	11ST175A
2"	16	16ST200A
2"	14	14ST200A
2"	11	11ST200A
2-1/8"	16	16ST212A
2-1/8"	11	11ST212A
2-1/4"	16	16ST225A
2-1/4"	14	14ST225A
2-1/4"	11	11ST225A
2-1/2"	16	16ST250A
2-1/2"	14	14ST250A
2-1/2"	11	11ST250A
3"	16	16ST300A
3"	14	14ST300A
3"	11	11ST300A
3-1/2"	16	16ST350A
3-1/2"	14	14ST350A
3-1/2"	11	11ST350A
4"	16	16ST400A
4"	14	14ST400A
4"	11	11ST400A
4-1/2"	14	14ST450A
4-1/2"	11	11ST450A
5"	14	14ST500A
5"	11	11ST500A
6"	14	14ST600A
6"	11	11ST600A
8"	14	14ST800A
8"	11	11ST800A
10"	12	12ST1000A

## CARBON STEEL

OD (IN.)	GAUGE	PRODUCT ID
1-1/2"	16	16WT150C
1-1/2"	14	14WT150C
1-1/2"	11	11WT150C
1-3/4"	16	16WT175C
1-3/4"	14	14WT175C
1-3/4"	11	11WT175C
2"	16	16WT200C
2"	14	14WT200C
2"	11	11WT200C
2-1/8"	16	16WT212C
2-1/8"	11	11WT212C
2-1/4"	16	16WT225C
2-1/4"	11	11WT225C
2-1/2"	16	16WT250C
2-1/2"	14	14WT250C
2-1/2"	11	11WT250C
3"	16	16WT300C
3"	14	14WT300C
3"	11	11WT300C
3-1/2"	16	16WT350C
3-1/2"	14	14WT350C
3-1/2"	11	11WT350C
4"	16	16WT400C
4"	14	14WT400C
4"	11	11WT400C
4-1/2"	14	14WT450C
4-1/2"	11	11WT450C
5"	14	14WT500C
5"	11	11WT500C
6"	14	14WT600C
6"	11	11WT600C
8"	14	14WT800C
8"	11	11WT800C
10"	12	12WT1000C

### NPS TO OD CONVERSION

3" NPS Sch 5 = 3-1/2" OD 14 Gauge  
 3" NPS Sch 10 = 3-1/2" OD 11 Gauge  
 3-1/2" NPS Sch 5 = 4" OD 14 Gauge  
 3-1/2" NPS Sch 10 = 4" OD 11 Gauge  
 4" NPS Sch 5 = 4-1/2" OD 14 Gauge  
 4" NPS Sch 10 = 4-1/2" OD 11 Gauge

### Tube Specifications

- ☉ 1-1/2" through 10" OD. Up to 14" special order!
- ☉ Wall Thickness: 16, 14, 12 & 11 Gauge
- ☉ Standard length is 20' But we will cut to your specifications

### Material type

A = Aluminum  
 C = Carbon  
 S = Stainless  
 Z = Galvanized

Order by Product ID Number

## STAINLESS STEEL

OD (IN.)	GAUGE	PRODUCT ID
1-1/2"	16	16WT150S
1-1/2"	14	14WT150S
1-1/2"	11	11WT150S
1-3/4"	16	16WT175S
1-3/4"	14	14WT175S
1-3/4"	11	11WT175S
2"	16	16WT200S
2"	14	14WT200S
2"	11	11WT200S
2-1/8"	16	16WT212S
2-1/8"	11	11WT212S
2-1/4"	16	16WT225S
2-1/4"	14	14WT225S
2-1/4"	11	11WT225S
2-1/2"	16	16WT250S
2-1/2"	14	14WT250S
2-1/2"	11	11WT250S
3"	16	16WT300S
3"	14	14WT300S
3"	11	11WT300S
3-1/2"	16	16WT350S
3-1/2"	14	5WP300S
3-1/2"	11	10WP300S
4"	16	16WT400S
4"	14	5WP350S
4"	11	10WP350S
4-1/2"	14	5WP400S
4-1/2"	11	10WP400S
5"	14	14WT500S
5"	11	11WT500S
6"	14	14WT600S
6"	11	11WT600S
8"	14	14WT800S
8"	11	11WT800S
10"	12	12WT1000S

## ZINC COATED (GALVANIZED)

OD (IN.)	GAUGE	PRODUCT ID
1-1/2"	16	16WT150Z
1-1/2"	11	11WT150Z
2"	16	16WT200Z
2-1/8"	16	16WT212Z
2-1/8"	11	11WT212Z
2-1/2"	16	16WT250Z
2-1/2"	11	11WT250Z
3"	16	16WT300Z
3"	11	11WT300Z
3-1/2"	16	16WT350Z
3-1/2"	11	11WT350Z
4"	16	16WT400Z
4"	11	11WT400Z
5"	14	14WT500Z
5"	11	11WT500Z
6"	14	14WT600Z
6"	11	11WT600Z
8"	14	14WT800Z
8"	11	11WT800Z
10"	12	12WT1000Z

### Tube Specifications

- ☉ 1-1/2" through 10" OD. Up to 14" special order!
- ☉ Wall Thickness: 16, 14, 12 & 11 Gauge
- ☉ Standard length is 20' But we will cut to your specifications

### Material type

- A = Aluminum
- C = Carbon
- S = Stainless
- Z = Galvanized

### TERMINOLOGY

- CLR Center Line Radius
- ERW Electric Resistance Welded
- FNPT Female National Pipe Thread
- ID Inside Diameter
- MNPT Male National Pipe Thread
- NPS Nominal Pipe Size
- OD Outside Diameter
- SCH Schedule



# TUBE BENDS

All reference dimensions are nominal

## 1-1/2" OD

OD (IN.)	GAUGE (WALL THICKNESS) & MATERIAL	CLR	DEGREE	PRODUCT ID
1-1/2"	16A, 16S, 14A, 14S, 11A, 11S	2.5"	90	150252
1-1/2"	16A, 16S, 14A, 14S, 11A, 11S	2.5"	60	150256
1-1/2"	16A, 16S, 14A, 14S, 11A, 11S	2.5"	45	150251
1-1/2"	16A, 16S, 14A, 14S, 11A, 11S	2.5"	30	150253
1-1/2"	16A, 16S, 14A, 14S, 11A, 11S	6"	90	150062
1-1/2"	16A, 16C, 16S, 14A, 14C, 14S, 11A, 11C, 11S	6	60	150066
1-1/2"	16A, 16C, 16S, 14A, 14C, 14S, 11A, 11C, 11S	6	45	150061
1-1/2"	16A, 16C, 16S, 14A, 14C, 14S, 11A, 11C, 11S	6	30	150063
1-1/2"	16A, 16C, 16S, 14A, 14C, 14S, 11A, 11C, 11S	9	90	150092
1-1/2"	16A, 16C, 16S, 14A, 14C, 14S, 11A, 11C, 11S	9	60	150096
1-1/2"	16A, 16C, 16S, 14A, 14C, 14S, 11A, 11C, 11S	9	45	150091
1-1/2"	16A, 16C, 16S, 14A, 14C, 14S, 11A, 11C, 11S	9	30	150093
1-1/2"	16A, 16C, 16S, 14A, 14C, 14S, 11A, 11C, 11S	12"	90	150122
1-1/2"	16A, 16C, 16S, 14A, 14C, 14S, 11A, 11C, 11S	12"	60	150126
1-1/2"	16A, 16C, 16S, 14A, 14C, 14S, 11A, 11C, 11S	12"	45	150121
1-1/2"	16A, 16C, 16S, 14A, 14C, 14S, 11A, 11C, 11S	12"	30	150123
1-1/2"	16A, 16C, 16S, 14A, 14C, 14S, 11A, 11C, 11S	18"	90	150182
1-1/2"	16A, 16C, 16S, 14A, 14C, 14S, 11A, 11C, 11S	18"	60	150186
1-1/2"	16A, 16C, 16S, 14A, 14C, 14S, 11A, 11C, 11S	18"	45	150181
1-1/2"	16A, 16C, 16S, 14A, 14C, 14S, 11A, 11C, 11S	18"	30	150183
1-1/2"	16A, 16C, 16S, 14A, 14C, 14S, 11A, 11C, 11S	24"	90	150242
1-1/2"	16A, 16C, 16S, 14A, 14C, 14S, 11A, 11C, 11S	24"	60	150246
1-1/2"	16A, 16C, 16S, 14A, 14C, 14S, 11A, 11C, 11S	24"	45	150241
1-1/2"	16A, 16C, 16S, 14A, 14C, 14S, 11A, 11C, 11S	24"	30	150243
1-1/2"	16A, 16C, 16S, 14A, 14C, 14S, 11A, 11C, 11S	30"	90	150302
1-1/2"	16A, 16C, 16S, 14A, 14C, 14S, 11A, 11C, 11S	30"	60	150306
1-1/2"	16A, 16C, 16S, 14A, 14C, 14S, 11A, 11C, 11S	30"	45	150301
1-1/2"	16A, 16C, 16S, 14A, 14C, 14S, 11A, 11C, 11S	30"	30	150303
1-1/2"	16A, 16C, 16S, 14A, 14C, 14S, 11A, 11C, 11S	36"	90	150362
1-1/2"	16A, 16C, 16S, 14A, 14C, 14S, 11A, 11C, 11S	36"	60	150366
1-1/2"	16A, 16C, 16S, 14A, 14C, 14S, 11A, 11C, 11S	36"	45	150361
1-1/2"	16A, 16C, 16S, 14A, 14C, 14S, 11A, 11C, 11S	36"	30	150363

### To determine your part number when ordering:

Use **GAUGE**  
plus **PRODUCT ID**  
plus **MATERIAL TYPE**

GAUGE    PRODUCT ID    MATERIAL TYPE

**16 - 150252 - A**

### Tube Specifications

- ☉ 1-1/2" through 10" OD. Up to 14" special order!
- ☉ Wall Thickness: 16, 14, 12 & 11 Gauge
- ☉ Standard length is 20' But we will cut to your specifications

### Material type

A = Aluminum  
C = Carbon  
S = Stainless  
Z = Galvanized

• Nominal standard tangent is two times OD, 6" minimum.

# TUBE BENDS

©2024 H-P Products

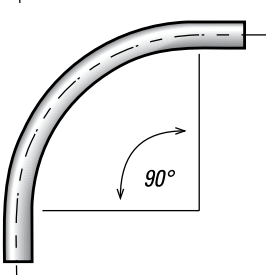
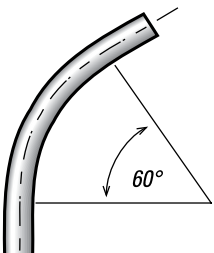
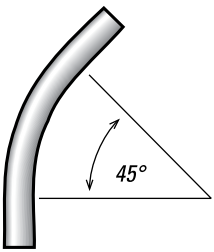
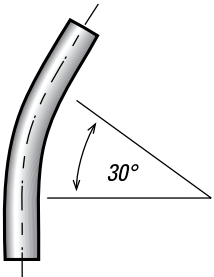

## 1-3/4" OD

OD (IN.)	GAUGE (WALL THICKNESS) & MATERIAL	CLR	DEGREE	PRODUCT ID
1-3/4"	16A, 16S, 14A, 14S, 11A, 11S	2.5"	90	175252
1-3/4"	16A, 16S, 14A, 14S, 11A, 11S	2.5"	60	175256
1-3/4"	16A, 16S, 14A, 14S, 11A, 11S	2.5"	45	175251
1-3/4"	16A, 16S, 14A, 14S, 11A, 11S	2.5"	30	175253
1-3/4"	16A, 16S, 14A, 14S, 11A, 11S	6"	90	175092
1-3/4"	16A, 16C, 16S, 14A, 14C, 14S, 11A, 11C, 11S	6"	60	175096
1-3/4"	16A, 16C, 16S, 14A, 14C, 14S, 11A, 11C, 11S	6"	45	175091
1-3/4"	16A, 16C, 16S, 14A, 14C, 14S, 11A, 11C, 11S	6"	30	175093
1-3/4"	16A, 16C, 16S, 14A, 14C, 14S, 11A, 11C, 11S	9"	90	175122
1-3/4"	16A, 16C, 16S, 14A, 14C, 14S, 11A, 11C, 11S	9"	60	175126
1-3/4"	16A, 16C, 16S, 14A, 14C, 14S, 11A, 11C, 11S	9"	45	175121
1-3/4"	16A, 16C, 16S, 14A, 14C, 14S, 11A, 11C, 11S	9"	30	175123
1-3/4"	16A, 16C, 16S, 14A, 14C, 14S, 11A, 11C, 11S	12"	90	175182
1-3/4"	16A, 16C, 16S, 14A, 14C, 14S, 11A, 11C, 11S	12"	60	175186
1-3/4"	16A, 16C, 16S, 14A, 14C, 14S, 11A, 11C, 11S	12"	45	175181
1-3/4"	16A, 16C, 16S, 14A, 14C, 14S, 11A, 11C, 11S	12"	30	175183
1-3/4"	16A, 16C, 16S, 14A, 14C, 14S, 11A, 11C, 11S	18"	90	175242
1-3/4"	16A, 16C, 16S, 14A, 14C, 14S, 11A, 11C, 11S	18"	60	175246
1-3/4"	16A, 16C, 16S, 14A, 14C, 14S, 11A, 11C, 11S	18"	45	175241
1-3/4"	16A, 16C, 16S, 14A, 14C, 14S, 11A, 11C, 11S	18"	30	175243
1-3/4"	16A, 16C, 16S, 14A, 14C, 14S, 11A, 11C, 11S	24"	90	175302
1-3/4"	16A, 16C, 16S, 14A, 14C, 14S, 11A, 11C, 11S	24"	60	175306
1-3/4"	16A, 16C, 16S, 14A, 14C, 14S, 11A, 11C, 11S	24"	45	175301
1-3/4"	16A, 16C, 16S, 14A, 14C, 14S, 11A, 11C, 11S	24"	30	175303
1-3/4"	16A, 16C, 16S, 14A, 14C, 14S, 11A, 11C, 11S	30"	90	175362
1-3/4"	16A, 16C, 16S, 14A, 14C, 14S, 11A, 11C, 11S	30"	60	175366
1-3/4"	16A, 16C, 16S, 14A, 14C, 14S, 11A, 11C, 11S	30"	45	175361
1-3/4"	16A, 16C, 16S, 14A, 14C, 14S, 11A, 11C, 11S	30"	30	175363

• Nominal standard tangent is two times OD, 6" minimum.

### TERMINOLOGY

CLR	Center Line Radius
ERW	Electric Resistance Welded
FNPT	Female National Pipe Thread
ID	Inside Diameter
MNPT	Male National Pipe Thread
NPS	Nominal Pipe Size
OD	Outside Diameter
SCH	Schedule

# TUBE BENDS

All reference dimensions are nominal

## 2" OD

OD (IN.)	GAUGE (WALL THICKNESS) & MATERIAL	CLR	DEGREE	PRODUCT ID
2"	16A, 16S, 14A, 14S, 11A, 11S	3"	90	200032
2"	16A, 16S, 14A, 14S, 11A, 11S	3"	60	200036
2"	16A, 16S, 14A, 14S, 11A, 11S	3"	45	200031
2"	16A, 16S, 14A, 14S, 11A, 11S	3"	30	200033
2"	16A, 16C, 16S, 14A, 14C, 14S, 11A, 11C, 11S	6"	90	200062
2"	16A, 16C, 16S, 14A, 14C, 14S, 11A, 11C, 11S	6"	60	200066
2"	16A, 16C, 16S, 14A, 14C, 14S, 11A, 11C, 11S	6"	45	200061
2"	16A, 16C, 16S, 14A, 14C, 14S, 11A, 11C, 11S	6"	30	200063
2"	16A, 16C, 16S, 14A, 14C, 14S, 11A, 11C, 11S	9"	90	200092
2"	16A, 16C, 16S, 14A, 14C, 14S, 11A, 11C, 11S	9"	60	200096
2"	16A, 16C, 16S, 14A, 14C, 14S, 11A, 11C, 11S	9"	45	200091
2"	16A, 16C, 16S, 14A, 14C, 14S, 11A, 11C, 11S	9"	30	200093
2"	16A, 16C, 16S, 14A, 14C, 14S, 11A, 11C, 11S	12"	90	200122
2"	16A, 16C, 16S, 14A, 14C, 14S, 11A, 11C, 11S	12"	60	200126
2"	16A, 16C, 16S, 14A, 14C, 14S, 11A, 11C, 11S	12"	45	200121
2"	16A, 16C, 16S, 14A, 14C, 14S, 11A, 11C, 11S	12"	30	200123
2"	16A, 16C, 16S, 14A, 14C, 14S, 11A, 11C, 11S	18"	90	200182
2"	16A, 16C, 16S, 14A, 14C, 14S, 11A, 11C, 11S	18"	60	200186
2"	16A, 16C, 16S, 14A, 14C, 14S, 11A, 11C, 11S	18"	45	200181
2"	16A, 16C, 16S, 14A, 14C, 14S, 11A, 11C, 11S	18"	30	200183
2"	16A, 16C, 16S, 14A, 14C, 14S, 11A, 11C, 11S	24"	90	200242
2"	16A, 16C, 16S, 14A, 14C, 14S, 11A, 11C, 11S	24"	60	200246
2"	16A, 16C, 16S, 14A, 14C, 14S, 11A, 11C, 11S	24"	45	200241
2"	16A, 16C, 16S, 14A, 14C, 14S, 11A, 11C, 11S	24"	30	200243
2"	16A, 16C, 16S, 14A, 14C, 14S, 11A, 11C, 11S	30"	90	200302
2"	16A, 16C, 16S, 14A, 14C, 14S, 11A, 11C, 11S	30"	60	200306
2"	16A, 16C, 16S, 14A, 14C, 14S, 11A, 11C, 11S	30"	45	200301
2"	16A, 16C, 16S, 14A, 14C, 14S, 11A, 11C, 11S	30"	30	200303
2"	16A, 16C, 16S, 14A, 14C, 14S, 11A, 11C, 11S	36"	90	200362
2"	16A, 16C, 16S, 14A, 14C, 14S, 11A, 11C, 11S	36"	60	200366
2"	16A, 16C, 16S, 14A, 14C, 14S, 11A, 11C, 11S	36"	45	200361
2"	16A, 16C, 16S, 14A, 14C, 14S, 11A, 11C, 11S	36"	30	200363

### To determine your part number when ordering:

Use **GAUGE**  
plus **PRODUCT ID**  
plus **MATERIAL TYPE**

GAUGE    PRODUCT ID    MATERIAL TYPE

**16 - 150252 - A**

### Tube Specifications

- ☉ 1-1/2" through 10" OD. Up to 14" special order!
- ☉ Wall Thickness: 16, 14, 12 & 11 Gauge
- ☉ Standard length is 20' But we will cut to your specifications

### Material type

A = Aluminum  
C = Carbon  
S = Stainless  
Z = Galvanized

# TUBE BENDS

©2024 H-P Products

## 2-1/4" OD

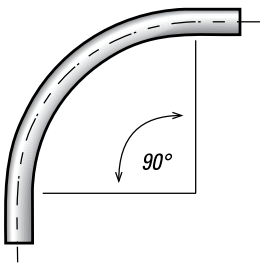
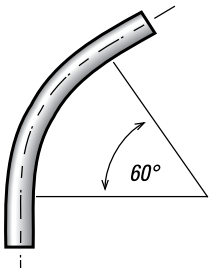
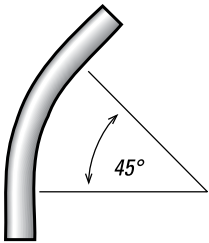
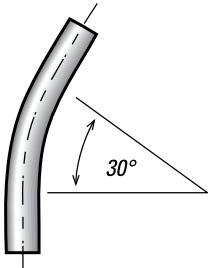

OD (IN.)	GAUGE (WALL THICKNESS) & MATERIAL	CLR	DEGREE	PRODUCT ID
2.25"	16A, 16S, 14A, 14S, 11A, 11S	4"	90	225042
2.25"	16A, 16S, 14A, 14S, 11A, 11S	4"	60	225046
2.25"	16A, 16S, 14A, 14S, 11A, 11S	4"	45	225041
2.25"	16A, 16S, 14A, 14S, 11A, 11S	4"	30	225043
2.25"	16A, 16S, 14A, 14S, 11A, 11S	9"	90	225092
2.25"	16A, 16C, 16S, 14A, 14C, 14S, 11A, 11C, 11S	9"	60	225096
2.25"	16A, 16C, 16S, 14A, 14C, 14S, 11A, 11C, 11S	9"	45	225091
2.25"	16A, 16C, 16S, 14A, 14C, 14S, 11A, 11C, 11S	9"	30	225093
2.25"	16A, 16C, 16S, 14A, 14C, 14S, 11A, 11C, 11S	12"	90	225122
2.25"	16A, 16C, 16S, 14A, 14C, 14S, 11A, 11C, 11S	12"	60	225126
2.25"	16A, 16C, 16S, 14A, 14C, 14S, 11A, 11C, 11S	12"	45	225121
2.25"	16A, 16C, 16S, 14A, 14C, 14S, 11A, 11C, 11S	12"	30	225123
2.25"	16A, 16C, 16S, 14A, 14C, 14S, 11A, 11C, 11S	18"	90	225182
2.25"	16A, 16C, 16S, 14A, 14C, 14S, 11A, 11C, 11S	18"	60	225186
2.25"	16A, 16C, 16S, 14A, 14C, 14S, 11A, 11C, 11S	18"	45	225181
2.25"	16A, 16C, 16S, 14A, 14C, 14S, 11A, 11C, 11S	18"	30	225183
2.25"	16A, 16C, 16S, 14A, 14C, 14S, 11A, 11C, 11S	24"	90	225242
2.25"	16A, 16C, 16S, 14A, 14C, 14S, 11A, 11C, 11S	24"	60	225246
2.25"	16A, 16C, 16S, 14A, 14C, 14S, 11A, 11C, 11S	24"	45	225241
2.25"	16A, 16C, 16S, 14A, 14C, 14S, 11A, 11C, 11S	24"	30	225243
2.25"	16A, 16C, 16S, 14A, 14C, 14S, 11A, 11C, 11S	30"	90	225302
2.25"	16A, 16C, 16S, 14A, 14C, 14S, 11A, 11C, 11S	30"	60	225306
2.25"	16A, 16C, 16S, 14A, 14C, 14S, 11A, 11C, 11S	30"	45	225301
2.25"	16A, 16C, 16S, 14A, 14C, 14S, 11A, 11C, 11S	30"	30	225303
2.25"	16A, 16C, 16S, 14A, 14C, 14S, 11A, 11C, 11S	36"	90	225362
2.25"	16A, 16C, 16S, 14A, 14C, 14S, 11A, 11C, 11S	36"	60	225366
2.25"	16A, 16C, 16S, 14A, 14C, 14S, 11A, 11C, 11S	36"	45	225361
2.25"	16A, 16C, 16S, 14A, 14C, 14S, 11A, 11C, 11S	36"	30	225363

### TERMINOLOGY

CLR	Center Line Radius
ERW	Electric Resistance Welded
FNPT	Female National Pipe Thread
ID	Inside Diameter
MNPT	Male National Pipe Thread
NPS	Nominal Pipe Size
OD	Outside Diameter
SCH	Schedule

# TUBE BENDS

All reference dimensions are nominal

## 2-1/2" OD

OD (IN.)	GAUGE (WALL THICKNESS) & MATERIAL	CLR	DEGREE	PRODUCT ID
2.5"	16A, 16S, 14A, 14S, 11A, 11S	4"	90	250042
2.5"	16A, 16S, 14A, 14S, 11A, 11S	4"	60	250046
2.5"	16A, 16S, 14A, 14S, 11A, 11S	4"	45	250041
2.5"	16A, 16S, 14A, 14S, 11A, 11S	4"	30	250043
2.5"	16A, 16C, 16S, 14A, 14C, 14S, 11A, 11C, 11S	6"	90	250062
2.5"	16A, 16C, 16S, 14A, 14C, 14S, 11A, 11C, 11S	6"	60	250066
2.5"	16A, 16C, 16S, 14A, 14C, 14S, 11A, 11C, 11S	6"	45	250061
2.5"	16A, 16C, 16S, 14A, 14C, 14S, 11A, 11C, 11S	6"	30	250063
2.5"	16A, 16C, 16S, 14A, 14C, 14S, 11A, 11C, 11S	9"	90	250092
2.5"	16A, 16C, 16S, 14A, 14C, 14S, 11A, 11C, 11S	9"	60	250096
2.5"	16A, 16C, 16S, 14A, 14C, 14S, 11A, 11C, 11S	9"	45	250091
2.5"	16A, 16C, 16S, 14A, 14C, 14S, 11A, 11C, 11S	9"	30	250093
2.5"	16A, 16C, 16S, 14A, 14C, 14S, 11A, 11C, 11S	12"	90	250122
2.5"	16A, 16C, 16S, 14A, 14C, 14S, 11A, 11C, 11S	12"	60	250126
2.5"	16A, 16C, 16S, 14A, 14C, 14S, 11A, 11C, 11S	12"	45	250121
2.5"	16A, 16C, 16S, 14A, 14C, 14S, 11A, 11C, 11S	12"	30	250123
2.5"	16A, 16C, 16S, 14A, 14C, 14S, 11A, 11C, 11S	18"	90	250182
2.5"	16A, 16C, 16S, 14A, 14C, 14S, 11A, 11C, 11S	18"	60	250186
2.5"	16A, 16C, 16S, 14A, 14C, 14S, 11A, 11C, 11S	18"	45	250181
2.5"	16A, 16C, 16S, 14A, 14C, 14S, 11A, 11C, 11S	18"	30	250183
2.5"	16A, 16C, 16S, 14A, 14C, 14S, 11A, 11C, 11S	24"	90	250242
2.5"	16A, 16C, 16S, 14A, 14C, 14S, 11A, 11C, 11S	24"	60	250246
2.5"	16A, 16C, 16S, 14A, 14C, 14S, 11A, 11C, 11S	24"	45	250241
2.5"	16A, 16C, 16S, 14A, 14C, 14S, 11A, 11C, 11S	24"	30	250243
2.5"	16A, 16C, 16S, 14A, 14C, 14S, 11A, 11C, 11S	30"	90	250302
2.5"	16A, 16C, 16S, 14A, 14C, 14S, 11A, 11C, 11S	30"	60	250306
2.5"	16A, 16C, 16S, 14A, 14C, 14S, 11A, 11C, 11S	30"	45	250301
2.5"	16A, 16C, 16S, 14A, 14C, 14S, 11A, 11C, 11S	30"	30	250303
2.5"	16A, 16C, 16S, 14A, 14C, 14S, 11A, 11C, 11S	36"	90	250362
2.5"	16A, 16C, 16S, 14A, 14C, 14S, 11A, 11C, 11S	36"	60	250366
2.5"	16A, 16C, 16S, 14A, 14C, 14S, 11A, 11C, 11S	36"	45	250361
2.5"	16A, 16C, 16S, 14A, 14C, 14S, 11A, 11C, 11S	36"	30	250363

### To determine your part number when ordering:

Use **GAUGE**  
plus **PRODUCT ID**  
plus **MATERIAL TYPE**

GAUGE    PRODUCT ID    MATERIAL TYPE

**16 - 150252 - A**

### Tube Specifications

- ☉ 1-1/2" through 10" OD. Up to 14" special order!
- ☉ Wall Thickness: 16, 14, 12 & 11 Gauge
- ☉ Standard length is 20' But we will cut to your specifications

### Material type

A = Aluminum  
C = Carbon  
S = Stainless  
Z = Galvanized

# TUBE BENDS

©2024 H-P Products

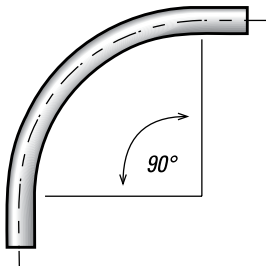
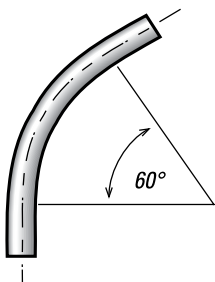
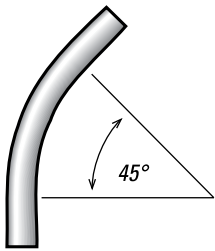
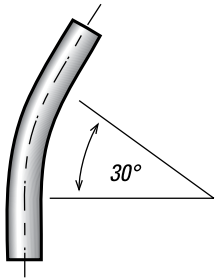

## 2-1/4" OD

OD (IN.)	GAUGE (WALL THICKNESS) & MATERIAL	CLR	DEGREE	PRODUCT ID
3.0"	16A, 16S, 14A, 14S, 11A, 11S	4"	90	300452
3.0"	16A, 16S, 14A, 14S, 11A, 11S	4"	60	300456
3.0"	16A, 16S, 14A, 14S, 11A, 11S	4"	45	300451
3.0"	16A, 16S, 14A, 14S, 11A, 11S	4"	30	300453
3.0"	16A, 16S, 14A, 14S, 11A, 11S	7.5"	90	300752
3.0"	16A, 16C, 16S, 14A, 14C, 14S, 11A, 11C, 11S	7.5"	60	300756
3.0"	16A, 16C, 16S, 14A, 14C, 14S, 11A, 11C, 11S	7.5"	45	300751
3.0"	16A, 16C, 16S, 14A, 14C, 14S, 11A, 11C, 11S	7.5"	30	300753
3.0"	16A, 16C, 16S, 14A, 14C, 14S, 11A, 11C, 11S	9"	90	300092
3.0"	16A, 16C, 16S, 14A, 14C, 14S, 11A, 11C, 11S	9"	60	300096
3.0"	16A, 16C, 16S, 14A, 14C, 14S, 11A, 11C, 11S	9"	45	300091
3.0"	16A, 16C, 16S, 14A, 14C, 14S, 11A, 11C, 11S	9"	30	300093
3.0"	16A, 16C, 16S, 14A, 14C, 14S, 11A, 11C, 11S	12"	90	300122
3.0"	16A, 16C, 16S, 14A, 14C, 14S, 11A, 11C, 11S	12"	60	300126
3.0"	16A, 16C, 16S, 14A, 14C, 14S, 11A, 11C, 11S	12"	45	300121
3.0"	16A, 16C, 16S, 14A, 14C, 14S, 11A, 11C, 11S	12"	30	300123
3.0"	16A, 16C, 16S, 14A, 14C, 14S, 11A, 11C, 11S	18"	90	300182
3.0"	16A, 16C, 16S, 14A, 14C, 14S, 11A, 11C, 11S	18"	60	300186
3.0"	16A, 16C, 16S, 14A, 14C, 14S, 11A, 11C, 11S	18"	45	300181
3.0"	16A, 16C, 16S, 14A, 14C, 14S, 11A, 11C, 11S	18"	30	300183
3.0"	16A, 16C, 16S, 14A, 14C, 14S, 11A, 11C, 11S	24"	90	300242
3.0"	16A, 16C, 16S, 14A, 14C, 14S, 11A, 11C, 11S	24"	60	300246
3.0"	16A, 16C, 16S, 14A, 14C, 14S, 11A, 11C, 11S	24"	45	300241
3.0"	16A, 16C, 16S, 14A, 14C, 14S, 11A, 11C, 11S	24"	30	300243
3.0"	16A, 16C, 16S, 14A, 14C, 14S, 11A, 11C, 11S	30"	90	300302
3.0"	16A, 16C, 16S, 14A, 14C, 14S, 11A, 11C, 11S	30"	60	300306
3.0"	16A, 16C, 16S, 14A, 14C, 14S, 11A, 11C, 11S	30"	45	300301
3.0"	16A, 16C, 16S, 14A, 14C, 14S, 11A, 11C, 11S	30"	30	300303
3.0"	16A, 16C, 16S, 14A, 14C, 14S, 11A, 11C, 11S	36"	90	300362
3.0"	16A, 16C, 16S, 14A, 14C, 14S, 11A, 11C, 11S	36"	60	300366
3.0"	16A, 16C, 16S, 14A, 14C, 14S, 11A, 11C, 11S	36"	45	300361
3.0"	16A, 16C, 16S, 14A, 14C, 14S, 11A, 11C, 11S	36"	30	300363

### TERMINOLOGY

CLR	Center Line Radius
ERW	Electric Resistance Welded
FNPT	Female National Pipe Thread
ID	Inside Diameter
MNPT	Male National Pipe Thread
NPS	Nominal Pipe Size
OD	Outside Diameter
SCH	Schedule

# TUBE BENDS

All reference dimensions are nominal

## 3-1/2" OD

OD (IN.)	GAUGE (WALL THICKNESS) & MATERIAL	CLR	DEGREE	PRODUCT ID
3.5"	16A, 16S, 14A, 14S, 11A, 11S	5"	90	350052
3.5"	16A, 16S, 14A, 14S, 11A, 11S	5"	60	350056
3.5"	16A, 16S, 14A, 14S, 11A, 11S	5"	45	350051
3.5"	16A, 16S, 14A, 14S, 11A, 11S	5"	30	350053
3.5"	16A, 16C, 16S, 14A, 14C, 14S, 11A, 11C, 11S	9"	90	350092
3.5"	16A, 16C, 16S, 14A, 14C, 14S, 11A, 11C, 11S	9"	60	350096
3.5"	16A, 16C, 16S, 14A, 14C, 14S, 11A, 11C, 11S	9"	45	350091
3.5"	16A, 16C, 16S, 14A, 14C, 14S, 11A, 11C, 11S	9"	30	350093
3.5"	16A, 16C, 16S, 14A, 14C, 14S, 11A, 11C, 11S	12"	90	350122
3.5"	16A, 16C, 16S, 14A, 14C, 14S, 11A, 11C, 11S	12"	60	350126
3.5"	16A, 16C, 16S, 14A, 14C, 14S, 11A, 11C, 11S	12"	45	350121
3.5"	16A, 16C, 16S, 14A, 14C, 14S, 11A, 11C, 11S	12"	30	350123
3.5"	16A, 16C, 16S, 14A, 14C, 14S, 11A, 11C, 11S	18"	90	350182
3.5"	16A, 16C, 16S, 14A, 14C, 14S, 11A, 11C, 11S	18"	60	350186
3.5"	16A, 16C, 16S, 14A, 14C, 14S, 11A, 11C, 11S	18"	45	350181
3.5"	16A, 16C, 16S, 14A, 14C, 14S, 11A, 11C, 11S	18"	30	350183
3.5"	16A, 16C, 16S, 14A, 14C, 14S, 11A, 11C, 11S	24"	90	350242
3.5"	16A, 16C, 16S, 14A, 14C, 14S, 11A, 11C, 11S	24"	60	350246
3.5"	16A, 16C, 16S, 14A, 14C, 14S, 11A, 11C, 11S	24"	45	350241
3.5"	16A, 16C, 16S, 14A, 14C, 14S, 11A, 11C, 11S	24"	30	350243
3.5"	16A, 16C, 16S, 14A, 14C, 14S, 11A, 11C, 11S	30"	90	350302
3.5"	16A, 16C, 16S, 14A, 14C, 14S, 11A, 11C, 11S	30"	60	350306
3.5"	16A, 16C, 16S, 14A, 14C, 14S, 11A, 11C, 11S	30"	45	350301
3.5"	16A, 16C, 16S, 14A, 14C, 14S, 11A, 11C, 11S	30"	30	350303
3.5"	16A, 16C, 16S, 14A, 14C, 14S, 11A, 11C, 11S	36"	90	350362
3.5"	16A, 16C, 16S, 14A, 14C, 14S, 11A, 11C, 11S	36"	60	350366
3.5"	16A, 16C, 16S, 14A, 14C, 14S, 11A, 11C, 11S	36"	45	350361
3.5"	16A, 16C, 16S, 14A, 14C, 14S, 11A, 11C, 11S	36"	30	350363

### To determine your part number when ordering:

Use **GAUGE**  
plus **PRODUCT ID**  
plus **MATERIAL TYPE**

GAUGE    PRODUCT ID    MATERIAL TYPE

**16 - 150252 - A**

### Tube Specifications

- ☉ 1-1/2" through 10" OD. Up to 14" special order!
- ☉ Wall Thickness: 16, 14, 12 & 11 Gauge
- ☉ Standard length is 20' But we will cut to your specifications

### Material type

A = Aluminum  
C = Carbon  
S = Stainless  
Z = Galvanized

• Nominal standard tangent is two times OD, 6" minimum.

# TUBE BENDS

©2024 H-P Products

## 4" OD

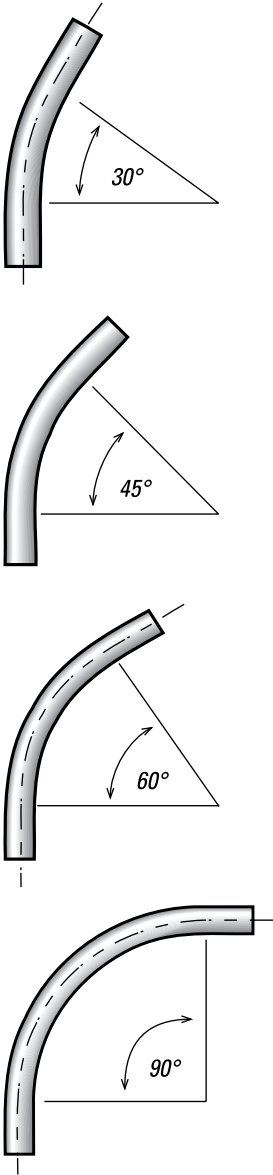

OD (IN.)	GAUGE (WALL THICKNESS) & MATERIAL	CLR	DEGREE	PRODUCT ID
4.0"	16A, 16S, 14A, 14S, 11A, 11S	6"	90	400062
4.0"	16A, 16C, 16S, 14A, 14C, 14S, 11A, 11C, 11S	6"	60	400066
4.0"	16A, 16C, 16S, 14A, 14C, 14S, 11A, 11C, 11S	6"	45	400061
4.0"	16A, 16C, 16S, 14A, 14C, 14S, 11A, 11C, 11S	6"	30	400063
4.0"	16A, 16C, 16S, 14A, 14C, 14S, 11A, 11C, 11S	9"	90	400092
4.0"	16A, 16C, 16S, 14A, 14C, 14S, 11A, 11C, 11S	9"	60	400096
4.0"	16A, 16C, 16S, 14A, 14C, 14S, 11A, 11C, 11S	9"	45	400091
4.0"	16A, 16C, 16S, 14A, 14C, 14S, 11A, 11C, 11S	9"	30	400093
4.0"	16A, 16C, 16S, 14A, 14C, 14S, 11A, 11C, 11S	12"	90	400122
4.0"	16A, 16C, 16S, 14A, 14C, 14S, 11A, 11C, 11S	12"	60	400126
4.0"	16A, 16C, 16S, 14A, 14C, 14S, 11A, 11C, 11S	12"	45	400121
4.0"	16A, 16C, 16S, 14A, 14C, 14S, 11A, 11C, 11S	12"	30	400123
4.0"	16A, 16C, 16S, 14A, 14C, 14S, 11A, 11C, 11S	18"	90	400182
4.0"	16A, 16C, 16S, 14A, 14C, 14S, 11A, 11C, 11S	18"	60	400186
4.0"	16A, 16C, 16S, 14A, 14C, 14S, 11A, 11C, 11S	18"	45	400181
4.0"	16A, 16C, 16S, 14A, 14C, 14S, 11A, 11C, 11S	18"	30	400183
4.0"	16A, 16C, 16S, 14A, 14C, 14S, 11A, 11C, 11S	24"	90	400242
4.0"	16A, 16C, 16S, 14A, 14C, 14S, 11A, 11C, 11S	24"	60	400246
4.0"	16A, 16C, 16S, 14A, 14C, 14S, 11A, 11C, 11S	24"	45	400241
4.0"	16A, 16C, 16S, 14A, 14C, 14S, 11A, 11C, 11S	24"	30	400243
4.0"	16A, 16C, 16S, 14A, 14C, 14S, 11A, 11C, 11S	30"	90	400302
4.0"	16A, 16C, 16S, 14A, 14C, 14S, 11A, 11C, 11S	30"	60	400306
4.0"	16A, 16C, 16S, 14A, 14C, 14S, 11A, 11C, 11S	30"	45	400301
4.0"	16A, 16C, 16S, 14A, 14C, 14S, 11A, 11C, 11S	30"	30	400303
4.0"	16A, 16C, 16S, 14A, 14C, 14S, 11A, 11C, 11S	36"	90	400362
4.0"	16A, 16C, 16S, 14A, 14C, 14S, 11A, 11C, 11S	36"	60	400366
4.0"	16A, 16C, 16S, 14A, 14C, 14S, 11A, 11C, 11S	36"	45	400361
4.0"	16A, 16C, 16S, 14A, 14C, 14S, 11A, 11C, 11S	36"	30	400363

• Nominal standard tangent is two times OD, 6" minimum.

### TERMINOLOGY

- CLR Center Line Radius
- ERW Electric Resistance Welded
- FNPT Female National Pipe Thread
- ID Inside Diameter
- MNPT Male National Pipe Thread
- NPS Nominal Pipe Size
- OD Outside Diameter
- SCH Schedule



# TUBE BENDS

All reference dimensions are nominal

## 4-1/2" OD

OD (IN.)	GAUGE (WALL THICKNESS) & MATERIAL	CLR	DEGREE	PRODUCT ID
4.5"	16A, 16C, 16S, 14A, 14C, 14S, 11A, 11C, 11S	9"	90	450092
4.5"	16A, 16C, 16S, 14A, 14C, 14S, 11A, 11C, 11S	9"	60	450096
4.5"	16A, 16C, 16S, 14A, 14C, 14S, 11A, 11C, 11S	9"	45	450091
4.5"	16A, 16C, 16S, 14A, 14C, 14S, 11A, 11C, 11S	9"	30	450093
4.5"	16A, 16C, 16S, 14A, 14C, 14S, 11A, 11C, 11S	12"	90	450122
4.5"	16A, 16C, 16S, 14A, 14C, 14S, 11A, 11C, 11S	12"	60	450126
4.5"	16A, 16C, 16S, 14A, 14C, 14S, 11A, 11C, 11S	12"	45	450121
4.5"	16A, 16C, 16S, 14A, 14C, 14S, 11A, 11C, 11S	12"	30	450123
4.5"	16A, 16C, 16S, 14A, 14C, 14S, 11A, 11C, 11S	18"	90	450182
4.5"	16A, 16C, 16S, 14A, 14C, 14S, 11A, 11C, 11S	18"	60	450186
4.5"	16A, 16C, 16S, 14A, 14C, 14S, 11A, 11C, 11S	18"	45	450181
4.5"	16A, 16C, 16S, 14A, 14C, 14S, 11A, 11C, 11S	18"	30	450183
4.5"	16A, 16C, 16S, 14A, 14C, 14S, 11A, 11C, 11S	24"	90	450242
4.5"	16A, 16C, 16S, 14A, 14C, 14S, 11A, 11C, 11S	24"	60	450246
4.5"	16A, 16C, 16S, 14A, 14C, 14S, 11A, 11C, 11S	24"	45	450241
4.5"	16A, 16C, 16S, 14A, 14C, 14S, 11A, 11C, 11S	24"	30	450243
4.5"	16A, 16C, 16S, 14A, 14C, 14S, 11A, 11C, 11S	30"	90	450302
4.5"	16A, 16C, 16S, 14A, 14C, 14S, 11A, 11C, 11S	30"	60	450306
4.5"	16A, 16C, 16S, 14A, 14C, 14S, 11A, 11C, 11S	30"	45	450301
4.5"	16A, 16C, 16S, 14A, 14C, 14S, 11A, 11C, 11S	30"	30	450303
4.5"	16A, 16C, 16S, 14A, 14C, 14S, 11A, 11C, 11S	36"	90	450362
4.5"	16A, 16C, 16S, 14A, 14C, 14S, 11A, 11C, 11S	36"	60	450366
4.5"	16A, 16C, 16S, 14A, 14C, 14S, 11A, 11C, 11S	36"	45	450361
4.5"	16A, 16C, 16S, 14A, 14C, 14S, 11A, 11C, 11S	36"	30	450363

### To determine your part number when ordering:

Use **GAUGE**  
plus **PRODUCT ID**  
plus **MATERIAL TYPE**

GAUGE    PRODUCT ID    MATERIAL TYPE

**16 - 150252 - A**

### Tube Specifications

- ☉ 1-1/2" through 10" OD. Up to 14" special order!
- ☉ Wall Thickness: 16, 14, 12 & 11 Gauge
- ☉ Standard length is 20' But we will cut to your specifications

### Material type

A = Aluminum  
C = Carbon  
S = Stainless  
Z = Galvanized

• Nominal standard tangent is two times OD, 6" minimum.

# TUBE BENDS

©2024 H-P Products

## 5" OD

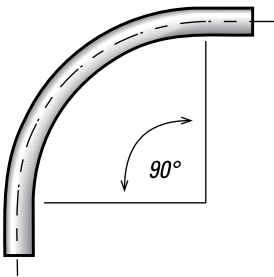
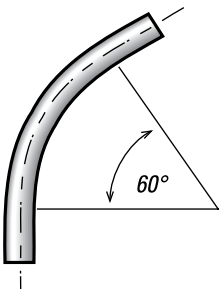
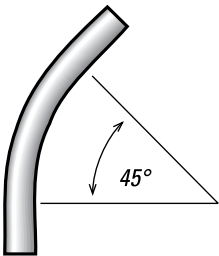
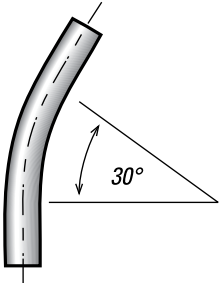

OD (IN.)	GAUGE (WALL THICKNESS) & MATERIAL	CLR	DEGREE	PRODUCT ID
5.0"	14A, 14C, 14S, 11A, 11C, 11S	7.5"	90	500752
5.0"	14A, 14C, 14S, 11A, 11C, 11S	7.5"	60	500756
5.0"	14A, 14C, 14S, 11A, 11C, 11S	7.5"	45	500751
5.0"	14A, 14C, 14S, 11A, 11C, 11S	7.5"	30	500753
5.0"	14A, 14C, 14S, 11A, 11C, 11S	12.5"	90	500122
5.0"	14A, 14C, 14S, 11A, 11C, 11S	12.5"	60	500126
5.0"	14A, 14C, 14S, 11A, 11C, 11S	12.5"	45	500121
5.0"	14A, 14C, 14S, 11A, 11C, 11S	12.5"	30	500123
5.0"	14A, 14C, 14S, 11A, 11C, 11S	18"	90	500182
5.0"	14A, 14C, 14S, 11A, 11C, 11S	18"	60	500186
5.0"	14A, 14C, 14S, 11A, 11C, 11S	18"	45	500181
5.0"	14A, 14C, 14S, 11A, 11C, 11S	18"	30	500183
5.0"	14A, 14C, 14S, 11A, 11C, 11S	24"	90	500242
5.0"	14A, 14C, 14S, 11A, 11C, 11S	24"	60	500246
5.0"	14A, 14C, 14S, 11A, 11C, 11S	24"	45	500241
5.0"	14A, 14C, 14S, 11A, 11C, 11S	24"	30	500243
5.0"	14A, 14C, 14S, 11A, 11C, 11S	30"	90	500302
5.0"	14A, 14C, 14S, 11A, 11C, 11S	30"	60	500306
5.0"	14A, 14C, 14S, 11A, 11C, 11S	30"	45	500301
5.0"	14A, 14C, 14S, 11A, 11C, 11S	30"	30	500303
5.0"	14A, 14C, 14S, 11A, 11C, 11S	36"	90	500362
5.0"	14A, 14C, 14S, 11A, 11C, 11S	36"	60	500366
5.0"	14A, 14C, 14S, 11A, 11C, 11S	36"	45	500361
5.0"	14A, 14C, 14S, 11A, 11C, 11S	36"	30	500363

• Nominal standard tangent is two times OD, 6" minimum.

### TERMINOLOGY

CLR	Center Line Radius
ERW	Electric Resistance Welded
FNPT	Female National Pipe Thread
ID	Inside Diameter
MNPT	Male National Pipe Thread
NPS	Nominal Pipe Size
OD	Outside Diameter
SCH	Schedule

# TUBE BENDS

All reference dimensions are nominal

## 6" OD

OD (IN.)	GAUGE (WALL THICKNESS) & MATERIAL	CLR	DEGREE	PRODUCT ID
6.0"	14A, 14C, 14S, 11A, 11C, 11S	9"	90	600092
6.0"	14A, 14C, 14S, 11A, 11C, 11S	9"	60	600096
6.0"	14A, 14C, 14S, 11A, 11C, 11S	9"	45	600091
6.0"	14A, 14C, 14S, 11A, 11C, 11S	9"	30	600093
6.0"	14A, 14C, 14S, 11A, 11C, 11S	15"	90	600152
6.0"	14A, 14C, 14S, 11A, 11C, 11S	15"	60	600156
6.0"	14A, 14C, 14S, 11A, 11C, 11S	15"	45	600151
6.0"	14A, 14C, 14S, 11A, 11C, 11S	15"	30	600153
6.0"	14A, 14C, 14S, 11A, 11C, 11S	18"	90	600242
6.0"	14A, 14C, 14S, 11A, 11C, 11S	18"	60	600246
6.0"	14A, 14C, 14S, 11A, 11C, 11S	18"	45	600241
6.0"	14A, 14C, 14S, 11A, 11C, 11S	18"	30	600243
6.0"	14A, 14C, 14S, 11A, 11C, 11S	24"	90	600302
6.0"	14A, 14C, 14S, 11A, 11C, 11S	24"	60	600306
6.0"	14A, 14C, 14S, 11A, 11C, 11S	24"	45	600301
6.0"	14A, 14C, 14S, 11A, 11C, 11S	24"	30	600303
6.0"	14A, 14C, 14S, 11A, 11C, 11S	30"	90	600362
6.0"	14A, 14C, 14S, 11A, 11C, 11S	30"	60	600366
6.0"	14A, 14C, 14S, 11A, 11C, 11S	30"	45	600361
6.0"	14A, 14C, 14S, 11A, 11C, 11S	30"	30	600363
6.0"	14A, 14C, 14S, 11A, 11C, 11S	36"	90	600482
6.0"	14A, 14C, 14S, 11A, 11C, 11S	36"	60	600486
6.0"	14A, 14C, 14S, 11A, 11C, 11S	36"	45	600481
6.0"	14A, 14C, 14S, 11A, 11C, 11S	36"	30	600483

### To determine your part number when ordering:

Use **GAUGE**  
plus **PRODUCT ID**  
plus **MATERIAL TYPE**

GAUGE    PRODUCT ID    MATERIAL TYPE

**16 - 150252 - A**

### Tube Specifications

- ☉ 1-1/2" through 10" OD.  
Up to 14" special order!
- ☉ Wall Thickness:  
16, 14, 12 & 11 Gauge
- ☉ Standard length is 20' But we will cut to your specifications

### Material type

A = Aluminum  
C = Carbon  
S = Stainless  
Z = Galvanized

• Nominal standard tangent is two times OD, 6" minimum.

# TUBE BENDS

©2024 H-P Products

## 8" OD

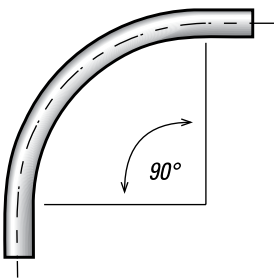
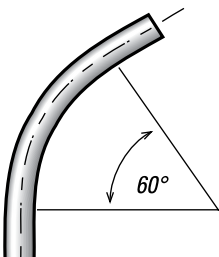
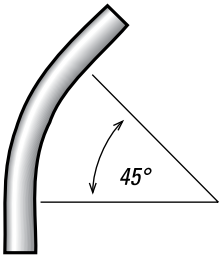
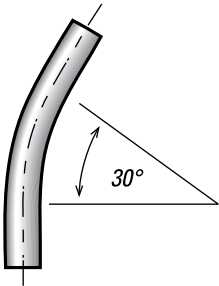

OD (IN.)	GAUGE (WALL THICKNESS) & MATERIAL	CLR	DEGREE	PRODUCT ID
8.0"	14A, 14C, 14S, 11A, 11C, 11S	12"	90	800122
8.0"	14A, 14C, 14S, 11A, 11C, 11S	12"	60	800126
8.0"	14A, 14C, 14S, 11A, 11C, 11S	12"	45	800121
8.0"	14A, 14C, 14S, 11A, 11C, 11S	12"	30	800123
8.0"	14A, 14C, 14S, 11A, 11C, 11S	20"	90	800202
8.0"	14A, 14C, 14S, 11A, 11C, 11S	20"	60	800206
8.0"	14A, 14C, 14S, 11A, 11C, 11S	20"	45	800201
8.0"	14A, 14C, 14S, 11A, 11C, 11S	20"	30	800203
8.0"	14A, 14C, 14S, 11A, 11C, 11S	32"	90	800322
8.0"	14A, 14C, 14S, 11A, 11C, 11S	32"	60	800326
8.0"	14A, 14C, 14S, 11A, 11C, 11S	32"	45	800321
8.0"	14A, 14C, 14S, 11A, 11C, 11S	32"	30	800323
8.0"	14A, 14C, 14S, 11A, 11C, 11S	48"	90	800482
8.0"	14A, 14C, 14S, 11A, 11C, 11S	48"	60	800486
8.0"	14A, 14C, 14S, 11A, 11C, 11S	48"	45	800481
8.0"	14A, 14C, 14S, 11A, 11C, 11S	48"	30	800483

• Nominal standard tangent is two times OD, 6" minimum.

### TERMINOLOGY

CLR	Center Line Radius
ERW	Electric Resistance Welded
FNPT	Female National Pipe Thread
ID	Inside Diameter
MNPT	Male National Pipe Thread
NPS	Nominal Pipe Size
OD	Outside Diameter
SCH	Schedule

# TUBE FITTINGS

All reference dimensions are nominal

## MITERED ELBOWS

OD (IN.)	GAUGE (WALL THICKNESS) & MATERIAL	A/B	PRODUCT ID
1-1/2"	16A,16C,16S,11A,11C,11S	6"	MIT150
2"	16A,16C,16S,11A,11C,11S	6"	MIT200
2-1/2"	16A,16C,16S,11A,11C,11S	6"	MIT250
3"	16A,16C,16S,11A,11C,11S	6"	MIT300
3-1/2"	16A,16C,16S,11A,11C,11S	7"	MIT350
4"	16A,16C,16S,11A,11C,11S	8"	MIT400
5"	14A,14C,14S,11A,11C,11S	10"	MIT500
6"	14A,14C,14S,11A,11C,11S	12"	MIT600
8"	14A,14C,14S,11A,11C,11S	16"	MIT800

### To determine your part number when ordering:

Use **GAUGE**  
plus **PRODUCT ID**  
plus **MATERIAL TYPE**

GAUGE    PRODUCT ID    MATERIAL TYPE

16 - 150252 - A

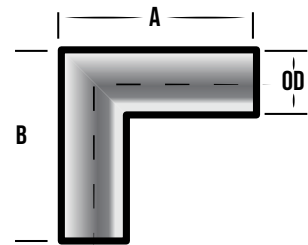

### Mitered Elbow Specifications

- ⊗ 1-1/2" through 8" OD
- ⊗ Wall Thickness: 16, 14 & 11 Gauge
- ⊗ Aluminum, Carbon & Stainless

Catalog Part Variations Available Upon Request

**GIVE US A CALL IF YOU CAN'T FIND EXACTLY WHAT YOU NEED!**

# TUBE FITTINGS

©2024 H-P Products

## To determine your part number when ordering:

Use **GAUGE**  
plus **PRODUCT ID**  
plus **MATERIAL TYPE**

GAUGE    PRODUCT ID    MATERIAL TYPE

**16 - 150252 - A**

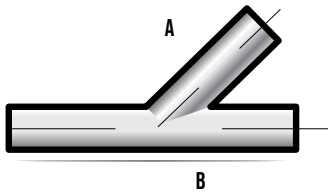

## Lateral Specifications

- ☉ 1-1/2" through 8" OD
- ☉ Wall Thickness: 16, 14 & 11 Gauge
- ☉ Aluminum, Carbon & Stainless

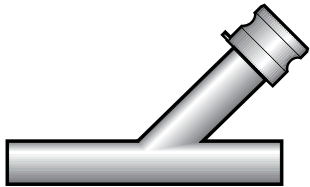

**Also available with  
Cam & Groove  
adapter/coupler  
welded to branch...Call!**

### TERMINOLOGY

CLR	Center Line Radius
ERW	Electric Resistance Welded
FNPT	Female National Pipe Thread
ID	Inside Diameter
MNPT	Male National Pipe Thread
NPS	Nominal Pipe Size
OD	Outside Diameter
SCH	Schedule

## TUBE LATERALS

OD	GAUGE (WALL THICKNESS) & MATERIAL	DEGREE	A	B	PRODUCT ID
1-1/2"	16A, 16C, 16S, 14A, 14C, 14S, 11A, 11C, 11S	30	8"	16"	LAT1503
1-1/2"	16A, 16C, 16S, 14A, 14C, 14S, 11A, 11C, 11S	45	8"	16"	LAT1501
1-3/4"	16A, 16C, 16S, 14A, 14C, 14S, 11A, 11C, 11S	30	8"	16"	LAT1753
1-3/4"	16A, 16C, 16S, 14A, 14C, 14S, 11A, 11C, 11S	45	8"	16"	LAT1751
2"	16A, 16C, 16S, 14A, 14C, 14S, 11A, 11C, 11S	30	8"	16"	LAT2003
2"	16A, 16C, 16S, 14A, 14C, 14S, 11A, 11C, 11S	45	8"	16"	LAT2001
2-1/4"	16A, 16C, 16S, 14A, 14C, 14S, 11A, 11C, 11S	30	8"	16"	LAT2253
2-1/4"	16A, 16C, 16S, 14A, 14C, 14S, 11A, 11C, 11S	45	8"	16"	LAT2251
2-1/2"	16A, 16C, 16S, 14A, 14C, 14S, 11A, 11C, 11S	30	8"	16"	LAT2503
2-1/2"	16A, 16C, 16S, 14A, 14C, 14S, 11A, 11C, 11S	45	8"	16"	LAT2501
3"	16A, 16C, 16S, 14A, 14C, 14S, 11A, 11C, 11S	30	10"	20"	LAT3003
3"	16A, 16C, 16S, 14A, 14C, 14S, 11A, 11C, 11S	45	8"	16"	LAT3001
3-1/2"	14A, 14C, 14S, 11A, 11C, 11S	30	10"	20"	LAT3503
3-1/2"	14A, 14C, 14S, 11A, 11C, 11S	45	8"	16"	LAT3501
4"	16A, 16C, 16S, 14A, 14C, 14S, 11A, 11C, 11S	30	12"	24"	LAT4003
4"	16A, 16C, 16S, 14A, 14C, 14S, 11A, 11C, 11S	45	10"	20"	LAT4001
4-1/2"	14A, 14C, 14S, 11A, 11C, 11S	30	12"	24"	LAT4503
4-1/2"	14A, 14C, 14S, 11A, 11C, 11S	45	10"	20"	LAT4501
5"	14A, 14C, 14S, 11A, 11C, 11S	30	15"	30"	LAT5003
5"	14A, 14C, 14S, 11A, 11C, 11S	45	12"	24"	LAT5001
6"	14A, 14C, 14S, 11A, 11C, 11S	30	18"	36"	LAT6003
6"	14A, 14C, 14S, 11A, 11C, 11S	45	15"	30"	LAT6001

# TUBE FITTINGS

All reference dimensions are nominal

## TUBE WYES

OD	GAUGE (WALL THICKNESS) & MATERIAL	DEGREE	C	D	PRODUCT ID
1-1/2"	16A, 16C, 16S, 14A, 14C, 14S, 11A, 11C, 11S	30	8"	8"	WYE1503
1-1/2"	16A, 16C, 16S, 14A, 14C, 14S, 11A, 11C, 11S	45	8"	8"	WYE1501
1-3/4"	16A, 16C, 16S, 14A, 14C, 14S, 11A, 11C, 11S	30	8"	8"	WYE1753
1-3/4"	16A, 16C, 16S, 14A, 14C, 14S, 11A, 11C, 11S	45	8"	8"	WYE1751
2"	16A, 16C, 16S, 14A, 14C, 14S, 11A, 11C, 11S	30	8"	8"	WYE2003
2"	16A, 16C, 16S, 14A, 14C, 14S, 11A, 11C, 11S	45	8"	8"	WYE2001
2-1/4"	16A, 16C, 16S, 14A, 14C, 14S, 11A, 11C, 11S	30	8"	8"	WYE2253
2-1/4"	16A, 16C, 16S, 14A, 14C, 14S, 11A, 11C, 11S	45	8"	8"	WYE2251
2-1/2"	16A, 16C, 16S, 14A, 14C, 14S, 11A, 11C, 11S	30	8"	8"	WYE2503
2-1/2"	16A, 16C, 16S, 14A, 14C, 14S, 11A, 11C, 11S	45	8"	8"	WYE2501
3"	16A, 16C, 16S, 14A, 14C, 14S, 11A, 11C, 11S	30	8"	8"	WYE3003
3"	16A, 16C, 16S, 14A, 14C, 14S, 11A, 11C, 11S	45	8"	8"	WYE3001
3-1/2"	16A, 16C, 16S, 14A, 14C, 14S, 11A, 11C, 11S	30	8"	8"	WYE3503
3-1/2"	16A, 16C, 16S, 14A, 14C, 14S, 11A, 11C, 11S	45	8"	8"	WYE3501
4"	16A, 16C, 16S, 14A, 14C, 14S, 11A, 11C, 11S	30	8"	8"	WYE4003
4"	16A, 16C, 16S, 14A, 14C, 14S, 11A, 11C, 11S	45	8"	8"	WYE4001
4-1/2"	14A, 14C, 14S, 11A, 11C, 11S	30	10"	10"	WYE4503
4-1/2"	14A, 14C, 14S, 11A, 11C, 11S	45	10"	10"	WYE4501
5"	14A, 14C, 14S, 11A, 11C, 11S	30	11"	11"	WYE5003
5"	14A, 14C, 14S, 11A, 11C, 11S	45	11"	11"	WYE5001
6"	14A, 14C, 14S, 11A, 11C, 11S	30	12"	12"	WYE6003
6"	14A, 14C, 14S, 11A, 11C, 11S	45	12"	12"	WYE6001

### To determine your part number when ordering:

Use **GAUGE**  
plus **PRODUCT ID**  
plus **MATERIAL TYPE**

GAUGE    PRODUCT ID    MATERIAL TYPE

**16 - 150252 - A**

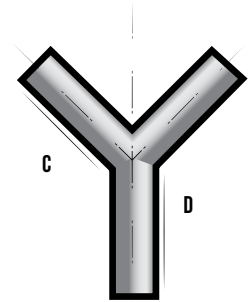

### Tube Wye Specifications

- ⊗ 1-1/2" through 8" OD
- ⊗ Wall Thickness: 16, 14 & 11 Gauge
- ⊗ Aluminum, Carbon & Stainless

# TUBE FITTINGS

©2024 H-P Products

## To determine your part number when ordering:

Use **GAUGE**  
plus **PRODUCT ID**  
plus **MATERIAL TYPE**

GAUGE    PRODUCT ID    MATERIAL TYPE

16 - 150252 - A

## Parallel Wye Specifications

- ☑ 1-1/2" through 6" OD
- ☑ Wall Thickness: 14 & 16 Gauge
- ☑ Aluminum, Carbon & Stainless
- ☑ 30 Degree available upon request

Typically used in single line pneumatic conveying systems to allow drops to multiple stations

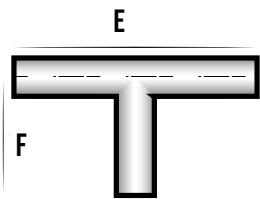

## Tee Specifications

- ☑ 1-1/2" through 6" OD
- ☑ Wall Thickness: 14 & 16 Gauge
- ☑ Aluminum, Carbon & Stainless

### TERMINOLOGY

CLR	Center Line Radius
ERW	Electric Resistance Welded
FNPT	Female National Pipe Thread
ID	Inside Diameter
MNPT	Male National Pipe Thread
NPS	Nominal Pipe Size
OD	Outside Diameter
SCH	Schedule

## PARALLEL WYES

OD (IN.)	GAUGE (WALL THICKNESS) & MATERIAL	DEGREE	PRODUCT ID
1-1/2"	16A, 16S	6"	PWYE1501
1-3/4"	16A, 16S	6"	PWYE1751
2"	16A, 16S	6"	PWYE2001
2-1/4"	16A, 16S	6"	PWYE2251
2-1/2"	16A, 16S	7"	PWYE2501
3"	16A, 16S	8"	PWYE3001
4"	16A, 16S	10"	PWYE4001
5"	14A, 14S	12"	PWYE5001
6"	14A, 14S	16"	PWYE6001

## BRANCH DIMENSIONS

OD	A	B	C	D	E	F	G
1.5	45	4	19.94	6	6	6	6.81
2	45	5	20.5	6	6	6	6.44
2.5	45	6	21	6	6	6	6
3	45	7.5	21.75	6	6	6	5.38
4	45	10	29	8	8	8	7.19
5	45	12.5	36.16	10	10	10	8.94
6	45	15	39.44	10	10	12	10.75

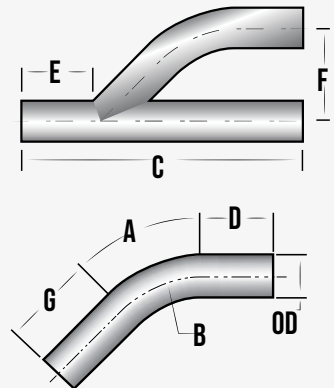

## TUBE TEES

OD	GAUGE (WALL THICKNESS) & MATERIAL	E	F	PRODUCT ID
1-1/2"	16A, 16C, 16S, 14A, 14C, 14S, 11A, 11C, 11S	16"	8"	TEE150
1-3/4"	16A, 16C, 16S, 14A, 14C, 14S, 11A, 11C, 11S	16"	8"	TEE175
2"	16A, 16C, 16S, 14A, 14C, 14S, 11A, 11C, 11S	16"	8"	TEE200
2-1/4"	16A, 16C, 16S, 14A, 14C, 14S, 11A, 11C, 11S	16"	8"	TEE225
2-1/2"	16A, 16C, 16S, 14A, 14C, 14S, 11A, 11C, 11S	16"	8"	TEE250
3"	16A, 16C, 16S, 14A, 14C, 14S, 11A, 11C, 11S	16"	8"	TEE300
3-1/2"	16A, 16C, 16S, 14A, 14C, 14S, 11A, 11C, 11S	16"	8"	TEE350
4"	16A, 16C, 16S, 14A, 14C, 14S, 11A, 11C, 11S	16"	8"	TEE400
4-1/2"	16A, 16C, 16S, 14A, 14C, 14S, 11A, 11C, 11S	18"	9"	TEE450
5"	14A, 14C, 14S, 11A, 11C, 11S	18"	9"	TEE500
6"	14A, 14C, 14S, 11A, 11C, 11S	20"	10"	TEE600



# TUBE FITTINGS

All reference dimensions are nominal

## FEMALE ADAPTERS

OD	FNPT	LENGTH	GAUGE	PRODUCT ID	MATERIAL
1-1/2"	1-1/2"	6"	16	FA-151	A, C, S
2"	2"	6"	16	FA-201	A, C, S
2-1/2"	2-1/2"	6"	16	FA-251	A, C, S
3"	3"	6"	16	FA-301	A, C, S
3-1/2"	3-1/2"	6"	16	FA-351	A, C, S
4"	4"	6-1/2"	16	FA-401	A, C, S
5"	5"	6-3/4"	14	FA-501	A, C, S
6"	6"	7"	14	FA-601	A, C, S
8"	8"	9-1/2"	14	FA-801	A, C, S

## MALE ADAPTERS

OD	FNPT	LENGTH	GAUGE	PRODUCT ID	MATERIAL
1-1/2"	1-1/2"	6"	16	MA-152	A, C, S
2"	2"	6"	16	MA-202	A, C, S
2-1/2"	2-1/2"	6"	16	MA-252	A, C, S
3"	3"	6"	16	MA-302	A, C, S
3-1/2"	3-1/2"	6"	16	MA-352	A, C, S
4"	4"	6"	16	MA-402	A, C, S
5"	5"	6-1/2"	14	MA-502	A, C, S
6"	6"	7"	14	MA-602	A, C, S
8"	8"	8-1/2"	14	MA-802	A, C, S

## PLATE FLANGES

OD	FNPT	LENGTH
2"	PFT200	A, C, S
2-1/8"	PFT212	A, C, S
2-1/2"	PFT250	A, C, S
3"	PFT300	A, C, S
4"	PFT400	A, C, S
5"	PFT500	A, C, S
6"	PFT600	A, C, S
8"	PFT800	A, C, S
10"	PFT1000	A, C, S
12"	PFT1200	A, C, S

## Adapter Specifications

- ☉ 1-1/2" through 8" OD
  - ☉ Wall Thickness: 16, 14 & 11 Gauge
  - ☉ Aluminum, Carbon & Stainless
- for joining tube to pipe**

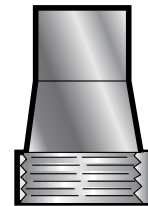

Female



Male

## Plate Flange Specifications

- ☉ 2" through 12" OD sizes available
- ☉ Slip-on, flat face style
- ☉ 1/2" thick, 150 lb. drilling
- ☉ All bolt pattern dimensions meet ANSI Standards
- ☉ Aluminum, Carbon & Stainless

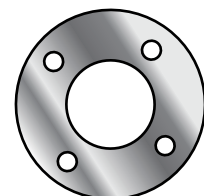

# TUBE FITTINGS

©2024 H-P Products

## To determine your part number when ordering:

Use **GAUGE**  
plus **PRODUCT ID**  
plus **MATERIAL TYPE**

GAUGE	PRODUCT ID	MATERIAL TYPE
16	- 150252	- A

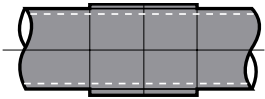

## SLIP COUPLINGS

FOR TUBE OD	LENGTH	GAUGE	PRODUCT ID	MATERIAL
1-1/2"	3"	16	SC-153	A, C, S
2"	3"	16	SC-203	A, C, S
2-1/2"	3-1/2"	16	SC-253	A, C, S
3"	3"	16	SC-303	A, C, S
3-1/2"	4-1/2"	16	SC-353	A, C, S
4"	5"	16	SC-403	A, C, S
5"	6-1/2"	14	SC-503	A, C, S
6"	7"	14	SC-603	A, C, S
8"	8"	14	SC-803	A, C, S
10"	10"	12	SC-1003	A, C, S
12"	12"	12	SC-1203	A, C, S

Used for joining the two straight ends of fittings or tubing. The slip coupling is a solid sleeve that fits the OD of the joint which can then be glued, brazed, welded or covered by shrink sleeves.

## SLIP COUPLINGS

FOR TUBE OD SIZE	PRODUCT ID
1-1/2"	SS-150
2" to 2-1/8"	SS-212
2-1/2" to 3"	SS-300
3-1/2" to 4"	SS-400
5"	SS-500
6"	SS-600
8"	SS-800
10"	SS-1000
12"	SS-1200
14"	SS-1400
12"	12"

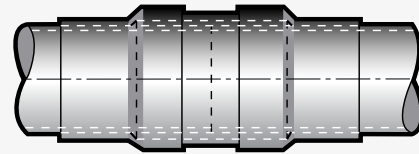

A heat shrinkable polyolefin band that literally shrinks and encircles the connection giving it mechanical strength and a positive seal. It can be used in conjunction with a slip coupling or when using expanded fittings. Gluing, brazing and welding operations are eliminated.

For use in systems under 15 PSIG.

## Slip Coupling Specifications

- ⊗ 1-1/2" through 6" OD
- ⊗ Wall Thickness: 14 & 16 Gauge
- ⊗ Aluminum, Carbon & Stainless

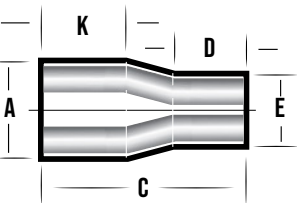

## Reducer Coupling Specifications

- ⊗ 1-1/2" through 4" OD
- ⊗ Wall Thickness: 16 Gauge
- ⊗ Aluminum

Offer longer tangent lengths so connection is possible with INSTALOK or compression couplings

### TERMINOLOGY

CLR	Center Line Radius
ERW	Electric Resistance Welded
FNPT	Female National Pipe Thread
ID	Inside Diameter
MNPT	Male National Pipe Thread
NPS	Nominal Pipe Size
OD	Outside Diameter
SCH	Schedule

## LONG-TANGENT REDUCER COUPLINGS

OD	GAUGE	A (OD)	E (OD)	C	D/K	PRODUCT ID
1-1/2" x 2"	16	2"	1-1/2"	6-15/16"	3"	RCLT-15X20-3AS
1-1/2" x 2-1/4"	16	2-1/4"	1-1/2"	7-3/8"	3"	RCLT-15X225-3AS
1-1/2" x 2-1/2"	16	2-1/2"	1-1/2"	7-3/8"	3"	RCLT-15X25-3AS
1-1/2" x 3"	16	3"	1-1/2"	8-13/16"	3"	RCLT-15X30-3AS
1-3/4" x 2"	16	2"	1-3/4"	6-7/16"	3"	RCLT-175X20-3AS
1-3/4" x 2-1/2"	16	2-1/2"	1-3/4"	7-3/8"	3"	RCLT-175X25-3AS
2" x 2-1/4"	16	2-1/4"	2"	6-7/16"	3"	RCLT-20X225-3AS
2" x 2-1/2"	16	2-1/2"	2"	6-15/16"	3"	RCLT-20X25-3AS
2" x 3"	16	3"	2"	7-7/8"	3"	RCLT-20X30-3AS
2-1/4" x 2-1/2"	16	2-1/2"	2-1/4"	6-7/16"	3"	RCLT-225X25-3AS
2-1/2" x 3"	16	3"	2-1/2"	7-1/2"	3"	RCLT-25X30-3AS
2-1/2" x 4"	16	4"	2-1/2"	14-1/4"	4"	RCLT-25X40-4AS*

• Welded construction

# PIPE

All reference dimensions are nominal

## ALUMINUM

NPS	SCHEDULE	PRODUCT ID
2"	5	16ST237A
2"	10	10SP200A
2"	40	40SP200A
2-1/2"	10	10SP250A
2-1/2"	40	40SP250A
3"	10	11ST350A
3"	40	40SP300A
3-1/2"	5	14ST400A
3-1/2"	10	11ST400A
3-1/2"	40	40SP350A
4"	10	11ST450A
4"	40	40SP400A
5"	10	10SP500A
5"	40	40SP500A
6"	10	10SP600A
6"	40	40SP600A
8"	10	10SP800A
8"	40	40SP800A

## CARBON STEEL

NPS	SCHEDULE	PRODUCT ID
1"	40	40WP100C
1"	80	80WP100C
1-1/4"	40	40WP125C
1-1/4"	80	80WP125C
1-1/2"	40	40WP150C
2"	5	5WP200C
2"	10	10WP200C
2"	40	40WP200C
2"	80	80WP200C
2-1/2"	5	5WP250C
2-1/2"	10	10WP250C
2-1/2"	40	40WP250C
2-1/2"	80	80WP250C
3"	5	14WT350C
3"	10	11WT350C
3"	40	40WP300C
3"	80	80WP300C
3-1/2"	5	14WT400C
3-1/2"	10	11WT400C
3-1/2"	40	40WP350C
3-1/2"	80	80WP350C
4"	5	14WT450C
4"	10	11WT450C
4"	40	40WP400C
4"	80	80WP400C
5"	10	10WP500C
5"	40	40WP500C
5"	80	80WP500C
6"	10	10WP600C
6"	40	40WP600C
6"	80	80WP600C
8"	10	10WP800C
8"	40	40WP800C
8"	80	80WP800C

### NPS TO OD CONVERSION

3" NPS Sch 5 = 3-1/2" OD 14 Gauge  
 3" NPS Sch 10 = 3-1/2" OD 11 Gauge  
 3-1/2" NPS Sch 5 = 4" OD 14 Gauge  
 3-1/2" NPS Sch 10 = 4" OD 11 Gauge  
 4" NPS Sch 5 = 4-1/2" OD 14 Gauge  
 4" NPS Sch 10 = 4-1/2" OD 11 Gauge

## Pipe Specifications

- ⊗ 1" through 8" NPS
- ⊗ Wall Thickness: Schedule 5, 10, 40, 80
- ⊗ Standard length is 20' or 21' But we will cut to your specs!
- ⊗ Aluminum, Carbon & Stainless

## Pipe Specifications

- ⊗ 1" through 8" NPS
- ⊗ Wall Thickness: Schedule 5, 10, 40, 80
- ⊗ Standard length is 20' or 21' But we will cut to your specs!
- ⊗ Aluminum, Carbon & Stainless

### TERMINOLOGY

- CLR Center Line Radius
- ERW Electric Resistance Welded
- FNPT Female National Pipe Thread
- ID Inside Diameter
- MNPT Male National Pipe Thread
- NPS Nominal Pipe Size
- OD Outside Diameter
- SCH Schedule

## STAINLESS STEEL

NPS	SCHEDULE	PRODUCT ID
1"	10	10WP100S
1"	40	40WP100S
1"	80	80WP100S
1-1/4"	40	40WP125S
1-1/4"	80	80WP125S
1-1/2"	10	10WP150S
1-1/2"	40	40WP150S
1-1/2"	80	80WP150S
2"	5	16WT237S
2"	10	10WP200S
2"	40	40WP200S
2"	80	80WP200S
2-1/2"	5	5WP250S
2-1/2"	10	10WP250S
2-1/2"	40	40WP250S
3"	5	5WP300S
3"	10	10WP300S
3"	40	40WP300S
3"	80	80WP300S
3-1/2"	5	5WP350S
3-1/2"	10	10WP350S
3-1/2"	40	40WP350S
4"	5	5WP400S
4"	10	10WP400S
4"	40	40WP400S
4"	80	80WP400S
5"	5	5WP500S
5"	10	10WP500S
5"	40	40WP500S
6"	10	10WP600S
6"	40	40WP600S
8"	10	10WP800S
8"	40	40WP800S

# PIPE BENDS

All reference dimensions are nominal

## 2" NPS

OD (IN.)	GAUGE (WALL THICKNESS) & MATERIAL	CLR	DEGREE	PRODUCT ID
2"	5P A, 5P C, 5P S, 10P A, 10P C, 10P S, 40P A, 40P C, 40P S	12	90	200122
2"	5P A, 5P C, 5P S, 10P A, 10P C, 10P S, 40P A, 40P C, 40P S	12	60	200126
2"	5P A, 5P C, 5P S, 10P A, 10P C, 10P S, 40P A, 40P C, 40P S	12	45	200121
2"	5P A, 5P C, 5P S, 10P A, 10P C, 10P S, 40P A, 40P C, 40P S	12	30	200123
2"	5P A, 5P C, 5P S, 10P A, 10P C, 10P S, 40P A, 40P C, 40P S	18	90	200182
2"	5P A, 5P C, 5P S, 10P A, 10P C, 10P S, 40P A, 40P C, 40P S	18	60	200186
2"	5P A, 5P C, 5P S, 10P A, 10P C, 10P S, 40P A, 40P C, 40P S	18	45	200181
2"	5P A, 5P C, 5P S, 10P A, 10P C, 10P S, 40P A, 40P C, 40P S	18	30	200183
2"	5P A, 5P C, 5P S, 10P A, 10P C, 10P S, 40P A, 40P C, 40P S	24	90	200242
2"	5P A, 5P C, 5P S, 10P A, 10P C, 10P S, 40P A, 40P C, 40P S	24	60	200246
2"	5P A, 5P C, 5P S, 10P A, 10P C, 10P S, 40P A, 40P C, 40P S	24	45	200241
2"	5P A, 5P C, 5P S, 10P A, 10P C, 10P S, 40P A, 40P C, 40P S	24	30	200243
2"	5P A, 5P C, 5P S, 10P A, 10P C, 10P S, 40P A, 40P C, 40P S	30	90	200302
2"	5P A, 5P C, 5P S, 10P A, 10P C, 10P S, 40P A, 40P C, 40P S	30	60	200306
2"	5P A, 5P C, 5P S, 10P A, 10P C, 10P S, 40P A, 40P C, 40P S	30	45	200301
2"	5P A, 5P C, 5P S, 10P A, 10P C, 10P S, 40P A, 40P C, 40P S	30	30	200303
2"	5P A, 5P C, 5P S, 10P A, 10P C, 10P S, 40P A, 40P C, 40P S	36	90	200362
2"	5P A, 5P C, 5P S, 10P A, 10P C, 10P S, 40P A, 40P C, 40P S	36	60	200366
2"	5P A, 5P C, 5P S, 10P A, 10P C, 10P S, 40P A, 40P C, 40P S	36	45	200361
2"	5P A, 5P C, 5P S, 10P A, 10P C, 10P S, 40P A, 40P C, 40P S	36	30	200363

• Nominal standard tangent is two times OD, 6" minimum.

## 2-1/2" NPS

OD (IN.)	GAUGE (WALL THICKNESS) & MATERIAL	CLR	DEGREE	PRODUCT ID
2.5"	5P A, 5P C, 5P S, 10P A, 10P C, 10P S, 40P A, 40P C, 40P S	24	90	250242
2.5"	5P A, 5P C, 5P S, 10P A, 10P C, 10P S, 40P A, 40P C, 40P S	24	60	250246
2.5"	5P A, 5P C, 5P S, 10P A, 10P C, 10P S, 40P A, 40P C, 40P S	24	45	250241
2.5"	5P A, 5P C, 5P S, 10P A, 10P C, 10P S, 40P A, 40P C, 40P S	24	30	250243
2.5"	5P A, 5P C, 5P S, 10P A, 10P C, 10P S, 40P A, 40P C, 40P S	30	90	250302
2.5"	5P A, 5P C, 5P S, 10P A, 10P C, 10P S, 40P A, 40P C, 40P S	30	60	250306
2.5"	5P A, 5P C, 5P S, 10P A, 10P C, 10P S, 40P A, 40P C, 40P S	30	45	250301
2.5"	5P A, 5P C, 5P S, 10P A, 10P C, 10P S, 40P A, 40P C, 40P S	30	30	250303
2.5"	5P A, 5P C, 5P S, 10P A, 10P C, 10P S, 40P A, 40P C, 40P S	36	90	250362
2.5"	5P A, 5P C, 5P S, 10P A, 10P C, 10P S, 40P A, 40P C, 40P S	36	60	250366
2.5"	5P A, 5P C, 5P S, 10P A, 10P C, 10P S, 40P A, 40P C, 40P S	36	45	250361
2.5"	5P A, 5P C, 5P S, 10P A, 10P C, 10P S, 40P A, 40P C, 40P S	36	30	250363

• Nominal standard tangent is two times OD, 6" minimum.

### To determine your part number when ordering:

Use **GAUGE**  
plus **PRODUCT ID**  
plus **MATERIAL TYPE**

GAUGE    PRODUCT ID    MATERIAL TYPE

**16 - 150252 - A**

### Pipe Bend Specifications

- ☉ • 2" through 6" NPS
- ☉ • Radius Options:
  - Short Radius  
(1-1/2" times NPS)
  - Standard Radius  
(2-1/2" times NPS)
  - Long Radius Bends  
(up through 60" CLR)
- ☉ Wall Thickness:
  - Schedule 5, 10 & 40  
(Sch. 80 available)
- ☉ Aluminum, Carbon & Stainless

# PIPE BENDS

©2024 H-P Products

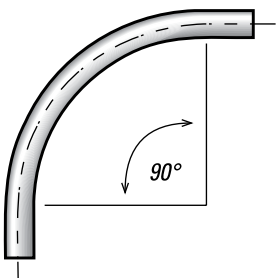
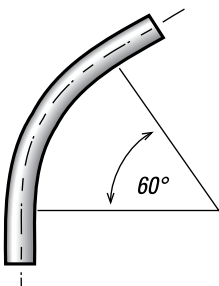
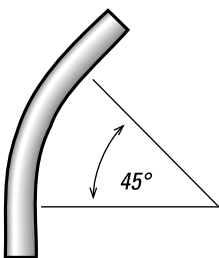
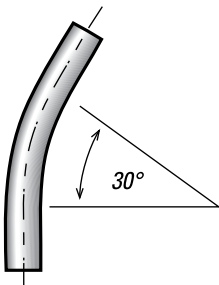

## 3" NPS

OD (IN.)	GAUGE (WALL THICKNESS) & MATERIAL	CLR	DEGREE	PRODUCT ID
3"	40P A, 40P C, 40P S	24	90	300242
3"	40P A, 40P C, 40P S	24	60	300246
3"	40P A, 40P C, 40P S	24	45	300241
3"	40P A, 40P C, 40P S	24	30	300243
3"	40P A, 40P C, 40P S	30	90	300302
3"	40P A, 40P C, 40P S	30	60	300306
3"	40P A, 40P C, 40P S	30	45	300301
3"	40P A, 40P C, 40P S	30	30	300303
3"	40P A, 40P C, 40P S	36	90	300362
3"	40P A, 40P C, 40P S	36	60	300366
3"	40P A, 40P C, 40P S	36	45	300361
3"	40P A, 40P C, 40P S	36	30	300363

• Nominal standard tangent is two times OD, 6" minimum.

## 3-1/2" NPS

OD (IN.)	GAUGE (WALL THICKNESS) & MATERIAL	CLR	DEGREE	PRODUCT ID
3.5"	40P A, 40P C, 40P S	24	90	350242
3.5"	40P A, 40P C, 40P S	24	60	350246
3.5"	40P A, 40P C, 40P S	24	45	350241
3.5"	40P A, 40P C, 40P S	24	30	350243
3.5"	40P A, 40P C, 40P S	30	90	350302
3.5"	40P A, 40P C, 40P S	30	60	350306
3.5"	40P A, 40P C, 40P S	30	45	350301
3.5"	40P A, 40P C, 40P S	30	30	350303
3.5"	40P A, 40P C, 40P S	36	90	350362
3.5"	40P A, 40P C, 40P S	36	60	350366
3.5"	40P A, 40P C, 40P S	36	45	350361
3.5"	40P A, 40P C, 40P S	36	30	350363

• Nominal standard tangent is two times OD, 6" minimum.

### TERMINOLOGY

CLR	Center Line Radius
ERW	Electric Resistance Welded
FNPT	Female National Pipe Thread
ID	Inside Diameter
MNPT	Male National Pipe Thread
NPS	Nominal Pipe Size
OD	Outside Diameter
SCH	Schedule

### NPS TO OD CONVERSION

3" NPS Sch 5 = 3-1/2" OD 14 Gauge  
 3" NPS Sch 10 = 3-1/2" OD 11 Gauge  
 3-1/2" NPS Sch 5 = 4" OD 14 Gauge  
 3-1/2" NPS Sch 10 = 4" OD 11 Gauge  
 4" NPS Sch 5 = 4-1/2" OD 14 Gauge  
 4" NPS Sch 10 = 4-1/2" OD 11 Gauge

# PIPE BENDS

All reference dimensions are nominal

## 4" NPS

OD (IN.)	GAUGE (WALL THICKNESS) & MATERIAL	CLR	DEGREE	PRODUCT ID
4"	40P A, 40P C, 40P S	24	90	400242
4"	40P A, 40P C, 40P S	24	60	400246
4"	40P A, 40P C, 40P S	24	45	400241
4"	40P A, 40P C, 40P S	24	30	400243
4"	40P A, 40P C, 40P S	30	90	400302
4"	40P A, 40P C, 40P S	30	60	400306
4"	40P A, 40P C, 40P S	30	45	400301
4"	40P A, 40P C, 40P S	30	30	400303
4"	40P A, 40P C, 40P S	36	90	400362
4"	40P A, 40P C, 40P S	36	60	400366
4"	40P A, 40P C, 40P S	36	45	400361
4"	40P A, 40P C, 40P S	36	30	400363

• Nominal standard tangent is two times OD, 6" minimum.

## 5" NPS

OD (IN.)	GAUGE (WALL THICKNESS) & MATERIAL	CLR	DEGREE	PRODUCT ID
5"	10P A, 10P C, 10P S, 40P A, 40P C, 40P S	24	90	500242
5"	10P A, 10P C, 10P S, 40P A, 40P C, 40P S	24	60	500246
5"	10P A, 10P C, 10P S, 40P A, 40P C, 40P S	24	45	500241
5"	10P A, 10P C, 10P S, 40P A, 40P C, 40P S	24	30	500243
5"	10P A, 10P C, 10P S, 40P A, 40P C, 40P S	30	90	500302
5"	10P A, 10P C, 10P S, 40P A, 40P C, 40P S	30	60	500306
5"	10P A, 10P C, 10P S, 40P A, 40P C, 40P S	30	45	500301
5"	10P A, 10P C, 10P S, 40P A, 40P C, 40P S	30	30	500303
5"	10P A, 10P C, 10P S, 40P A, 40P C, 40P S	36	90	500362
5"	10P A, 10P C, 10P S, 40P A, 40P C, 40P S	36	60	500366
5"	10P A, 10P C, 10P S, 40P A, 40P C, 40P S	36	45	500361
5"	10P A, 10P C, 10P S, 40P A, 40P C, 40P S	36	30	500363
5"	10P A, 10P C, 10P S, 40P A, 40P C, 40P S	48	90	500482
5"	10P A, 10P C, 10P S, 40P A, 40P C, 40P S	48	60	500486
5"	10P A, 10P C, 10P S, 40P A, 40P C, 40P S	48	45	500481
5"	10P A, 10P C, 10P S, 40P A, 40P C, 40P S	48	30	500483

• Nominal standard tangent is two times OD, 6" minimum.

### To determine your part number when ordering:

Use GAUGE  
plus PRODUCT ID  
plus MATERIAL TYPE

GAUGE    PRODUCT ID    MATERIAL TYPE

**16 - 150252 - A**

### Pipe Bend Specifications

- ☑ • 2" through 6" NPS
- ☑ • Radius Options:
  - Short Radius (1-1/2" times NPS)
  - Standard Radius (2-1/2" times NPS)
  - Long Radius Bends (up through 60" CLR)
- ☑ Wall Thickness:
  - Schedule 5, 10 & 40 (Sch. 80 available)
- ☑ Aluminum, Carbon & Stainless

# PIPE BENDS

©2024 H-P Products

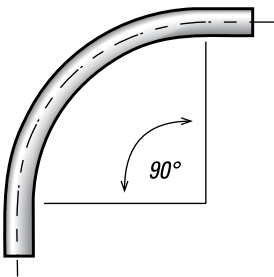
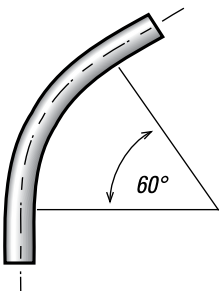
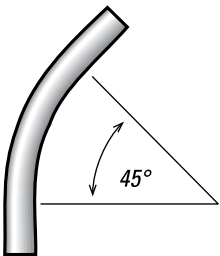
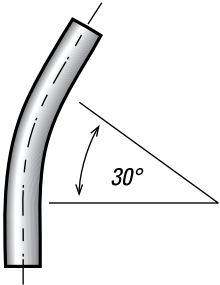

## 6" NPS

OD (IN.)	GAUGE (WALL THICKNESS) & MATERIAL	CLR	DEGREE	PRODUCT ID
6"	10P A, 10P C, 10P S, 40P A, 40P C, 40P S	24	90	600242
6"	10P A, 10P C, 10P S, 40P A, 40P C, 40P S	24	60	600246
6"	10P A, 10P C, 10P S, 40P A, 40P C, 40P S	24	45	600241
6"	10P A, 10P C, 10P S, 40P A, 40P C, 40P S	24	30	600243

• Nominal standard tangent is two times OD, 6" minimum.

### NPS TO OD CONVERSION

3" NPS Sch 5 = 3-1/2" OD 14 Gauge  
 3" NPS Sch 10 = 3-1/2" OD 11 Gauge  
 3-1/2" NPS Sch 5 = 4" OD 14 Gauge  
 3-1/2" NPS Sch 10 = 4" OD 11 Gauge  
 4" NPS Sch 5 = 4-1/2" OD 14 Gauge  
 4" NPS Sch 10 = 4-1/2" OD 11 Gauge

### TERMINOLOGY

CLR	Center Line Radius
ERW	Electric Resistance Welded
FNPT	Female National Pipe Thread
ID	Inside Diameter
MNPT	Male National Pipe Thread
NPS	Nominal Pipe Size
OD	Outside Diameter
SCH	Schedule



# PIPE FITTINGS

All reference dimensions are nominal

## PIPE LATERALS

NPS	SCHEDULE (WALL THICKNESS) & MATERIAL	DEGREE	A	B	PRODUCT ID
2"	5P A, 5P C, 5P S, 10P A, 10P C, 10P S, 40P A, 40P C, 40P S	30	8"	16"	LAT2003
2"	5P A, 5P C, 5P S, 10P A, 10P C, 10P S, 40P A, 40P C, 40P S	45	8"	16"	LAT2001
2.5"	5P A, 5P C, 5P S, 10P A, 10P C, 10P S, 40P A, 40P C, 40P S	30	8"	16"	LAT2503
2.5"	5P A, 5P C, 5P S, 10P A, 10P C, 10P S, 40P A, 40P C, 40P S	45	8"	16"	LAT2501
3"	40P A, 40P C, 40P S	30	10"	20"	LAT3003
3"	40P A, 40P C, 40P S	45	8"	16"	LAT3001
3.5"	40P A, 40P C, 40P S	30	10"	20"	LAT3503
3.5"	40P A, 40P C, 40P S	45	8"	16"	LAT3501
4"	40P A, 40P C, 40P S	30	12"	24"	LAT4003
4"	40P A, 40P C, 40P S	45	10"	20"	LAT4001
5"	5P A, 5P C, 5P S, 10P A, 10P C, 10P S, 40P A, 40P C, 40P S	30	15"	30"	LAT5003
5"	5P A, 5P C, 5P S, 10P A, 10P C, 10P S, 40P A, 40P C, 40P S	45	12"	24"	LAT5001
6"	5P A, 5P C, 5P S, 10P A, 10P C, 10P S, 40P A, 40P C, 40P S	30	18"	36"	LAT6003
6"	5P A, 5P C, 5P S, 10P A, 10P C, 10P S, 40P A, 40P C, 40P S	45	15"	30"	LAT6001

### To determine your part number when ordering:

Use GAUGE  
plus PRODUCT ID  
plus MATERIAL TYPE

GAUGE    PRODUCT ID    MATERIAL TYPE

**16 - 150252 - A**

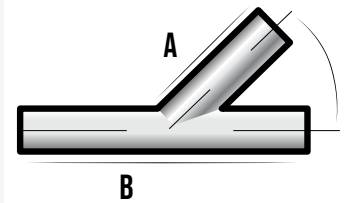

### Lateral Specifications

- ☑ 2 through 8" NPS
- ☑ Wall Thickness:
  - Schedule 5, 10 & 40
  - (Sch. 80 available)
- ☑ Aluminum, Carbon & Stainless

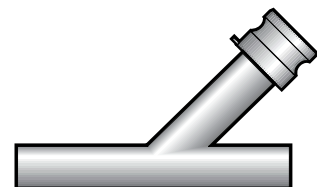

**Also available with  
Cam & Groove  
adapter/coupler  
welded to branch...Call!**

# PIPE FITTINGS

©2024 H-P Products

## To determine your part number when ordering:

Use **GAUGE**  
plus **PRODUCT ID**  
plus **MATERIAL TYPE**

GAUGE    PRODUCT ID    MATERIAL TYPE  
**16 - 150252 - A**

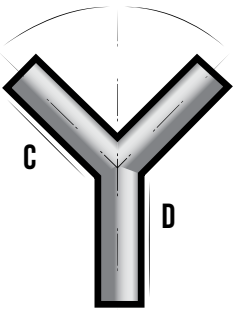

## PIPE WYES

NPS	SCHEDULE (WALL THICKNESS) & MATERIAL	DEGREE	A	B	PRODUCT ID
2"	5P A, 5P C, 5P S, 10P A, 10P C, 10P S, 40P A, 40P C, 40P S	30	8"	8"	WYE2003
2"	5P A, 5P C, 5P S, 10P A, 10P C, 10P S, 40P A, 40P C, 40P S	45	8"	8"	WYE2001
2-1/2"	5P A, 5P C, 5P S, 10P A, 10P C, 10P S, 40P A, 40P C, 40P S	30	8"	8"	WYE2503
2-1/2"	5P A, 5P C, 5P S, 10P A, 10P C, 10P S, 40P A, 40P C, 40P S	45	8"	8"	WYE2501
3"	40P A, 40P C, 40P S	30	8"	8"	WYE3003
3"	40P A, 40P C, 40P S	45	8"	8"	WYE3001
4"	40P A, 40P C, 40P S	30	8"	8"	WYE4003
4"	40P A, 40P C, 40P S	45	8"	8"	WYE4001
5"	10P A, 10P C, 10P S, 40P A, 40P C, 40P S	30	11"	11"	WYE5003
5"	10P A, 10P C, 10P S, 40P A, 40P C, 40P S	45	11"	11"	WYE5001
6"	10P A, 10P C, 10P S, 40P A, 40P C, 40P S	30	12"	12"	WYE6003
6"	10P A, 10P C, 10P S, 40P A, 40P C, 40P S	45	12"	12"	WYE6001
8"	10P A, 10P C, 10P S, 40P A, 40P C, 40P S	30	14"	14"	WYE8003
8"	10P A, 10P C, 10P S, 40P A, 40P C, 40P S	45	14"	14"	WYE8001

## Pipe Wye Specifications

- ☉ 2 through 8" NPS
- ☉ Wall Thickness:
  - Schedule 5, 10 & 40
  - (Sch. 80 available)
- ☉ Aluminum, Carbon & Stainless

### TERMINOLOGY

CLR	Center Line Radius
ERW	Electric Resistance Welded
FNPT	Female National Pipe Thread
ID	Inside Diameter
MNPT	Male National Pipe Thread
NPS	Nominal Pipe Size
OD	Outside Diameter
SCH	Schedule

# PIPE FITTINGS

All reference dimensions are nominal

## PIPE TEES

NPS	SCHEDULE (WALL THICKNESS) & MATERIAL	A	B	PRODUCT ID
2"	5P A, 5P C, 5P S, 10P A, 10P C, 10P S, 40P A, 40P C, 40P S	16"	8"	TEE200
2-1/2"	5P A, 5P C, 5P S, 10P A, 10P C, 10P S, 40P A, 40P C, 40P S	16"	8"	TEE250
3"	40P A, 40P C, 40P S	16"	8"	TEE300
3-1/2"	5P A, 5P C, 5P S, 10P A, 10P C, 10P S, 40P A, 40P C, 40P S	16"	8"	TEE350
4"	40P A, 40P C, 40P S	16"	8"	TEE400
5"	10P A, 10P C, 10P S, 40P A, 40P C, 40P S	18"	9"	TEE500
6"	10P A, 10P C, 10P S, 40P A, 40P C, 40P S	20"	10"	TEE600
8"	10P A, 10P C, 10P S, 40P A, 40P C, 40P S	24"	12"	TEE800

### To determine your part number when ordering:

Use **GAUGE**  
plus **PRODUCT ID**  
plus **MATERIAL TYPE**

GAUGE    PRODUCT ID    MATERIAL TYPE

**16 - 150252 - A**

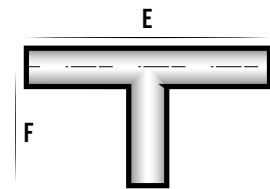

### Tee Specifications

- ☑ 2 through 8" NPS
- ☑ Wall Thickness:
  - Schedule 5, 10 & 40
  - (Sch. 80 available)
- ☑ Aluminum, Carbon & Stainless

## PLATE FLANGES

NPS	PRODUCT ID	MATERIAL
2"	PFP200	A, C, S
3"	PFP300	A, C, S
4"	PFP400	A, C, S
5"	PFP500	A, C, S
6"	PFP600	A, C, S
8"	PFP800	A, C, S

### Plate Flange Specifications

- ☑ 2" through 8" NPS sizes
- ☑ Slip-on, flat face style
- ☑ 1/2" thick, 150 lb. drilling
- ☑ All bolt pattern dimensions meet ANSI Standards
- ☑ Aluminum, Carbon & Stainless

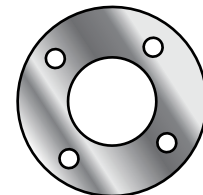

Catalog Part Variations Available Upon Request

**GIVE US A CALL IF YOU CAN'T FIND EXACTLY WHAT YOU NEED!**

# METHODS OF JOINING

©2024 H-P Products

## INSTALOK™ Specifications

- ⊗ 1-1/2" OD to 4" OD
- ⊗ 20% Lower cost than traditional couplings
- ⊗ 30% Quicker installation
- ⊗ Couplings have a unique clamping design that offers unparalleled strength and grip
- ⊗ Made with Grade 5 stress relieved bolts to ensure durability
- ⊗ Standard O-ring is black nitrile
- ⊗ Galvanized Steel Construction

**We also offer replacement O-rings, nuts, bolts and clamps**

**O-Ring Options include: Black, White, and Viton**

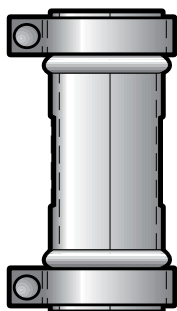

### TERMINOLOGY

CLR	Center Line Radius
ERW	Electric Resistance Welded
FNPT	Female National Pipe Thread
ID	Inside Diameter
MNPT	Male National Pipe Thread
NPS	Nominal Pipe Size
OD	Outside Diameter
SCH	Schedule

## H-P INSTALOK

OD	NPS	O-RING	LENGTH	PRODUCT ID
1-1/2"	.	Black	4"	CP15042B-16Z
1-1/2"	.	White	4"	CP15042W-16Z
1-1/2"	.	Black	6"	CP15062B-16Z
1-1/2"	.	White	6"	CP15062W-16Z
1-3/4"	.	Black	4"	CP17542B-16Z
1-3/4"	.	White	4"	CP17542W-16Z
1-3/4"	.	Black	6"	CP17562B-16Z
1-3/4"	.	White	6"	CP17562W-16Z
2"	.	Black	4"	CP20042B-16Z
2"	.	White	4"	CP20042W-16Z
2"	.	Black	6"	CP20062B-16Z
2"	.	White	6"	CP20062W-16Z
2-1/8"	.	Black	4"	CP21242B-16Z
2-1/8"	.	White	4"	CP21242W-16Z
2-1/8"	.	Black	6"	CP21262B-16Z
2-1/8"	.	White	6"	CP21262W-16Z
2-1/4"	.	Black	4"	CP22542B-16Z
2-1/4"	.	White	4"	CP22542W-16Z
2-1/4"	.	Black	6"	CP22562B-16Z
2-1/4"	.	White	6"	CP22562W-16Z
2-3/8"	2"	Black	4"	CP237542B-16Z
2-3/8"	2"	White	4"	CP237542W-16Z
2-3/8"	2"	Black	6"	CP237562B-16Z
2-3/8"	2"	White	6"	CP237562W-16Z
2-3/8"	2"	Black	8"	CP237582B-16Z
2-3/8"	2"	White	8"	CP237582W-16Z
2-1/2"	.	Black	4"	CP25042B-16Z
2-1/2"	.	White	4"	CP25042W-16Z
2-1/2"	.	Black	6"	CP25062B-16Z
2-1/2"	.	White	6"	CP25062W-16Z
2-1/2"	.	Black	8"	CP25082B-16Z
2-1/2"	.	White	8"	CP25082W-16Z
2-7/8"	2-1/2"	Black	4"	CP287542B-16Z
2-7/8"	2-1/2"	White	4"	CP287542W-16Z
2-7/8"	2-1/2"	Black	6"	CP287562B-16Z
2-7/8"	2-1/2"	White	6"	CP287562W-16Z
2-7/8"	2-1/2"	Black	8"	CP287582B-16Z
2-7/8"	2-1/2"	White	8"	CP287582W-16Z

Order by Product ID Number Only

# METHODS OF JOINING

All reference dimensions are nominal

## H-P INSTALOK

OD	NPS	O-RING	LENGTH	PRODUCT ID
3"	.	Black	4"	CP30042B-16Z
3"	.	White	4"	CP30042W-16Z
3"	.	Black	6"	CP30062B-16Z
3"	.	White	6"	CP30062W-16Z
3"	.	Black	8"	CP30082B-16Z
3"	.	White	8"	CP30082W-16Z
3-1/2"	3"	Black	4"	CP35042B-16Z
3-1/2"	3"	White	4"	CP35042W-16Z
3-1/2"	3"	Black	6"	CP35062B-16Z
3-1/2"	3"	White	6"	CP35062W-16Z
3-1/2"	3"	Black	8"	CP35082B-16Z
3-1/2"	3"	White	8"	CP35082W-16Z
4"	3-1/2"	Black	4"	CP40042B-16Z
4"	3-1/2"	White	4"	CP40042W-16Z
4"	3-1/2"	Black	6"	CP40062B-16Z
4"	3-1/2"	White	6"	CP40062W-16Z
4"	3-1/2"	Black	8"	CP40082B-16Z
4"	3-1/2"	White	8"	CP40082W-16Z

Order by  
Product ID  
Number  
Only

## H-P INSTALOK DUST CAPS

OD	NPS	O-RING	LENGTH	PRODUCT ID
1-1/2"	.	Black	3"	DC-150-B
1-3/4"	.	Black	3"	DC-175-B
2"	.	Black	3"	DC-200-B
2-1/4"	.	Black	3"	DC-225-B
2-1/2"	.	Black	3"	DC-250-B
3"	.	Black	3"	DC-300-B
3-1/2"	3"	Black	3"	DC-350-B
4"	3-1/2"	Black	3"	DC-400-B

Order by  
Product ID  
Number  
Only

## INSTALOK™ Specifications

- ☑ 1-1/2" OD to 4" OD
- ☑ 20% Lower cost than traditional
- ☑ couplings
- ☑ 30% Quicker installation
- ☑ Couplings have a unique clamping design that offers unparalleled strength and grip
- ☑ Made with Grade 5 stress relieved bolts to ensure durability
- ☑ Standard O-ring is black nitrile
- ☑ Galvanized Steel Construction

**We also offer replacement O-rings, nuts, bolts and clamps**

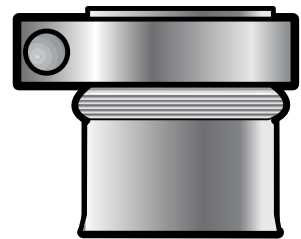

Catalog Part Variations Available Upon Request

**GIVE US A CALL IF YOU CAN'T FIND EXACTLY WHAT YOU NEED!**

# METHODS OF JOINING

©2024 H-P Products

## To determine your part number when ordering:

Use **GAUGE**  
plus **PRODUCT ID**  
plus **MATERIAL TYPE**

GAUGE    PRODUCT ID    MATERIAL TYPE

**16 - 150252 - A**

### WE ALSO CARRY...

- Replacement Gaskets
- Gasket Protection
- Static Strips
- Nuts & Bolts

*Please Call for Assistance*

**Compression couplings are available with and without gasket protectors.**

### In the protector column:

11 = with gasket protector  
10 = no gasket protector

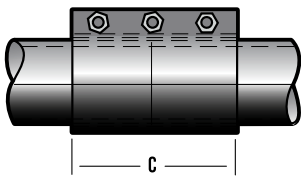

**COMPRESSION COUPLING**

Additional sizes available upon request

### TERMINOLOGY

CLR	Center Line Radius
ERW	Electric Resistance Welded
FNPT	Female National Pipe Thread
ID	Inside Diameter
MNPT	Male National Pipe Thread
NPS	Nominal Pipe Size
OD	Outside Diameter
SCH	Schedule

## COMPRESSION COUPLINGS

SIZE	ID	NPS SIZE	METRIC	PRODUCT ID	BOLTS	GASKET	PROTECTOR	LENGTH
1-1/2"	1.500	.	38.1	1500	2	B	10	4
.	1.500	.	38.1	1500	2	B	11	4
.	1.500	.	38.1	1500	2	W	10	4
.	1.500	.	38.1	1500	2	W	11	4
.	1.500	.	38.1	1500	3	B	10	6
.	1.500	.	38.1	1500	3	B	11	6
.	1.500	.	38.1	1500	3	W	10	6
.	1.500	.	38.1	1500	3	W	11	6
1-3/4"	1.750	.	44.45	1750	2	B	10	4
.	1.750	.	44.45	1750	2	B	11	4
.	1.750	.	44.45	1750	2	W	10	4
.	1.750	.	44.45	1750	2	W	11	4
.	1.750	.	44.45	1750	3	B	10	6
.	1.750	.	44.45	1750	3	B	11	6
.	1.750	.	44.45	1750	3	W	10	6
.	1.750	.	44.45	1750	3	W	11	6
1-29/32"	1.900	1-1/2"	48.26	1900	2	B	10	4
.	1.900	1-1/2"	48.26	1900	2	B	11	4
.	1.900	1-1/2"	48.26	1900	2	W	10	4
.	1.900	1-1/2"	48.26	1900	2	W	11	4
.	1.900	1-1/2"	48.26	1900	3	B	10	6
.	1.900	1-1/2"	48.26	1900	3	B	11	6
.	1.900	1-1/2"	48.26	1900	3	W	10	6
.	1.900	1-1/2"	48.26	1900	3	W	11	6
2"	2.000	.	50.8	2000	2	B	10	4
.	2.000	.	50.8	2000	2	B	11	4
.	2.000	.	50.8	2000	2	W	10	4
.	2.000	.	50.8	2000	2	W	11	4
.	2.000	.	50.8	2000	3	B	10	6
.	2.000	.	50.8	2000	3	B	11	6
.	2.000	.	50.8	2000	3	W	10	6
.	2.000	.	50.8	2000	3	W	11	6
2-1/8"	2.125	.	53.975	2125	2	B	10	4
.	2.125	.	53.975	2125	2	B	11	4
.	2.125	.	53.975	2125	2	W	10	4
.	2.125	.	53.975	2125	2	W	11	4
.	2.125	.	53.975	2125	3	B	10	6
.	2.125	.	53.975	2125	3	B	11	6
.	2.125	.	53.975	2125	3	W	10	6
.	2.125	.	53.975	2125	3	W	11	6
2-1/4"	2.250	.	57.15	2250	3	B	10	6
.	2.250	.	57.15	2250	3	B	11	6
.	2.250	.	57.15	2250	3	W	10	6
.	2.250	.	57.15	2250	3	W	11	6

# METHODS OF JOINING

All reference dimensions are nominal

## COMPRESSION COUPLINGS

SIZE	ID	NPS SIZE	METRIC	PRODUCT ID	BOLTS	GASKET	PROTECTOR	LENGTH
2-3/8"	2.375	2"	60.325	2375	3	B	10	6
.	2.375	2"	60.325	2375	3	B	11	6
.	2.375	2"	60.325	2375	3	W	10	6
.	2.375	2"	60.325	2375	3	W	11	6
.	2.375	2"	60.325	2375	4	B	10	8
.	2.375	2"	60.325	2375	4	B	11	8
.	2.375	2"	60.325	2375	4	W	10	8
.	2.375	2"	60.325	2375	4	W	11	8
2-1/2"	2.500	.	63.5	2500	2	B	10	4
.	2.500	.	63.5	2500	2	B	11	4
.	2.500	.	63.5	2500	2	W	10	4
.	2.500	.	63.5	2500	2	W	11	4
.	2.500	.	63.5	2500	3	B	10	6
.	2.500	.	63.5	2500	3	B	11	6
.	2.500	.	63.5	2500	3	R	10	6
.	2.500	.	63.5	2500	3	R	11	6
.	2.500	.	63.5	2500	3	W	10	6
.	2.500	.	63.5	2500	3	W	11	6
.	2.500	.	63.5	2500	4	B	10	8
.	2.500	.	63.5	2500	4	B	11	8
.	2.500	.	63.5	2500	4	W	10	8
.	2.500	.	63.5	2500	4	W	11	8
2-7/8"	2.875	2.5"	73.025	2875	3	B	10	6
.	2.875	2.5"	73.025	2875	3	B	11	6
.	2.875	2.5"	73.025	2875	3	W	10	6
.	2.875	2.5"	73.025	2875	3	W	11	6
3"	3.000	.	76.2	3000	2	B	10	4
.	3.000	.	76.2	3000	2	B	11	4
.	3.000	.	76.2	3000	2	W	10	4
.	3.000	.	76.2	3000	2	W	11	4
.	3.000	.	76.2	3000	3	B	10	6
.	3.000	.	76.2	3000	3	B	11	6
.	3.000	.	76.2	3000	3	W	10	6
.	3.000	.	76.2	3000	3	W	11	6
.	3.000	.	76.2	3000	3	R	10	6
.	3.000	.	76.2	3000	3	R	11	6
.	3.000	.	76.2	3000	4	B	10	8
.	3.000	.	76.2	3000	4	B	11	8
.	3.000	.	76.2	3000	4	W	10	8
.	3.000	.	76.2	3000	4	W	11	8
3-1/2"	3.500	3	88.9	3500	3	B	10	6
.	3.500	3	88.9	3500	3	B	11	6
.	3.500	3	88.9	3500	3	W	10	6
.	3.500	3	88.9	3500	3	W	11	6
.	3.500	3	88.9	3500	4	B	11	6

### Coupling Specifications

- ☑ 1-1/2" through 14" OD for tube
  - ☑ 1-1/2" through 8" NPS for pipe
  - ☑ Heavy 16 gauge outer shell on all couplings over 3-1/4" in diameter provides added strength and dimensional stability.
  - ☑ G90 galvanized exterior coating provides superior corrosion resistance.
  - ☑ Reinforcement bars are zinc plated steel to provide additional strength and stability.
  - ☑ Grade 5 stress relieved bolts ensure durability.
  - ☑ Industry compatible, precision die cut black neoprene gasket ensures a tight seal.
  - ☑ Stainless steel strip guards against static electricity build-up.
- Stainless steel compression couplings available upon request.*
- Stainless steel gasket protectors are also available.*

### Other gaskets:

- White Nitrile
- Red Rubber
- Silicone
- EPDM
- Viton

### Call for information!

# METHODS OF JOINING

©2024 H-P Products

## To determine your part number when ordering:

Use **GAUGE**  
plus **PRODUCT ID**  
plus **MATERIAL TYPE**

GAUGE    PRODUCT ID    MATERIAL TYPE

**16 - 150252 - A**

### WE ALSO CARRY...

- Replacement Gaskets
- Gasket Protection
- Static Strips
- Nuts & Bolts

*Please Call for Assistance*

**Compression couplings are available with and without gasket protectors.**

### In the protector column:

11 = with gasket protector  
10 = no gasket protector

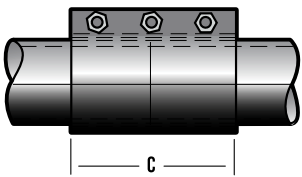

**COMPRESSION COUPLING**

Additional sizes available upon request

### TERMINOLOGY

CLR	Center Line Radius
ERW	Electric Resistance Welded
FNPT	Female National Pipe Thread
ID	Inside Diameter
MNPT	Male National Pipe Thread
NPS	Nominal Pipe Size
OD	Outside Diameter
SCH	Schedule

## COMPRESSION COUPLINGS

SIZE	ID	NPS SIZE	METRIC	PRODUCT ID	BOLTS	GASKET	PROTECTOR	LENGTH
3-1/2"	3.500	3	88.9	3500	4	B	11	8
.	3.500	3	88.9	3500	4	W	10	8
.	3.500	3	88.9	3500	4	W	11	8
4"	4.000	3.5	101.6	4000	2	B	10	4
.	4.000	3.5	101.6	4000	2	B	11	4
.	4.000	3.5	101.6	4000	2	W	10	4
.	4.000	3.5	101.6	4000	2	W	11	4
.	4.000	3.5	101.6	4000	3	B	10	6
.	4.000	3.5	101.6	4000	3	B	11	6
.	4.000	3.5	101.6	4000	3	R	10	6
.	4.000	3.5	101.6	4000	3	R	11	6
.	4.000	3.5	101.6	4000	3	W	10	6
.	4.000	3.5	101.6	4000	3	W	11	6
.	4.000	3.5	101.6	4000	4	B	10	8
.	4.000	3.5	101.6	4000	4	B	11	8
.	4.000	3.5	101.6	4000	4	W	10	8
.	4.000	3.5	101.6	4000	4	W	11	8
4-1/2"	4.500	4	114.3	4500	2	B	10	4
.	4.500	4	114.3	4500	2	B	11	4
.	4.500	4	114.3	4500	2	W	10	4
.	4.500	4	114.3	4500	2	W	11	4
.	4.500	4	114.3	4500	3	B	10	6
.	4.500	4	114.3	4500	3	B	11	6
.	4.500	4	114.3	4500	3	W	10	6
.	4.500	4	114.3	4500	3	W	11	6
.	4.500	4	114.3	4500	4	B	10	8
.	4.500	4	114.3	4500	4	B	11	8
.	4.500	4	114.3	4500	4	W	10	8
.	4.500	4	114.3	4500	4	W	11	8
5"	5.000	.	127	5000	2	B	10	4
.	5.000	.	127	5000	2	B	11	4
.	5.000	.	127	5000	2	W	10	4
.	5.000	.	127	5000	2	W	11	6
.	5.000	.	127	5000	3	B	10	6
.	5.000	.	127	5000	3	B	11	6
.	5.000	.	127	5000	3	R	10	6
.	5.000	.	127	5000	3	R	11	6
.	5.000	.	127	5000	3	W	10	6
.	5.000	.	127	5000	3	W	11	8
.	5.000	.	127	5000	4	B	10	8
.	5.000	.	127	5000	4	B	11	8
.	5.000	.	127	5000	4	W	10	8
.	5.000	.	127	5000	4	W	11	6
5-9/16"	5.563	5	141.3	5563	3	B	11	6
.	5.563	5	141.3	5563	3	B	11	6
.	5.563	5	141.3	5563	3	W	10	3
.	5.563	5	141.3	5563	3	W	11	6



# METHODS OF JOINING

All reference dimensions are nominal

## COMPRESSION COUPLINGS

SIZE	ID	NPS SIZE	METRIC	PRODUCT ID	BOLTS	GASKET	PROTECTOR	LENGTH
5-9/16"	5.563	5	141.3	5563	4	B	10	8
.	5.563	5	141.3	5563	4	B	11	8
.	5.563	5	141.3	5563	4	W	10	8
.	5.563	5	141.3	5563	4	W	11	8
6"	6.000	.	152.4	6000	2	B	10	4
.	6.000	.	152.4	6000	2	B	11	4
.	6.000	.	152.4	6000	2	W	10	4
.	6.000	.	152.4	6000	2	W	11	4
.	6.000	.	152.4	6000	3	B	10	6
.	6.000	.	152.4	6000	3	B	11	6
.	6.000	.	152.4	6000	3	R	10	6
.	6.000	.	152.4	6000	3	R	11	6
.	6.000	.	152.4	6000	3	W	10	6
.	6.000	.	152.4	6000	3	W	11	6
.	6.000	.	152.4	6000	4	B	10	8
.	6.000	.	152.4	6000	4	B	11	8
.	6.000	.	152.4	6000	4	R	10	8
.	6.000	.	152.4	6000	4	R	11	8
.	6.000	.	152.4	6000	4	W	10	8
.	6.000	.	152.4	6000	4	W	11	8
.	6.000	.	152.4	6000	5	W	10	10
.	6.000	.	152.4	6000	5	W	11	10
.	6.000	.	152.4	6000	5	B	10	10
.	6.000	.	152.4	6000	5	B	11	10
6-5/8"	6.625	6	168.3	6625	3	B	10	6
.	6.625	6	168.3	6625	3	B	11	6
.	6.625	6	168.3	6625	3	W	10	6
.	6.625	6	168.3	6625	3	W	11	6
.	6.625	6	168.3	6625	4	B	10	8
.	6.625	6	168.3	6625	4	B	11	8
.	6.625	6	168.3	6625	4	W	10	8
.	6.625	6	168.3	6625	4	W	11	8
.	6.625	6	168.3	6625	5	B	10	10
.	6.625	6	168.3	6625	5	B	11	10
.	6.625	6	168.3	6625	5	W	10	10
.	6.625	6	168.3	6625	5	W	11	10
7"	7.000	.	177.8	7000	3	B	10	8
.	7.000	.	177.8	7000	3	B	11	8
.	7.000	.	177.8	7000	3	W	10	8
.	7.000	.	177.8	7000	3	W	11	8
.	7.000	.	177.8	7000	4	B	10	10
.	7.000	.	177.8	7000	4	B	11	10
.	7.000	.	177.8	7000	4	W	10	10
.	7.000	.	177.8	7000	4	W	11	10
8"	8.000	.	203.2	8000	2	B	10	6
8"	8.000	.	203.2	8000	2	B	11	6

### Coupling Specifications

- ☑ 1-1/2" through 14" OD for tube
  - ☑ 1-1/2" through 8" NPS for pipe
  - ☑ Heavy 16 gauge outer shell on all couplings over 3-1/4" in diameter provides added strength and dimensional stability.
  - ☑ G90 galvanized exterior coating provides superior corrosion resistance.
  - ☑ Reinforcement bars are zinc plated steel to provide additional strength and stability.
  - ☑ Grade 5 stress relieved bolts ensure durability.
  - ☑ Industry compatible, precision die cut black neoprene gasket ensures a tight seal.
  - ☑ Stainless steel strip guards against static electricity build-up.
- Stainless steel compression couplings available upon request.*
- Stainless steel gasket protectors are also available.*

### Other gaskets:

White Nitrile  
Red Rubber  
Silicone  
EPDM  
Viton

### Call for information!

# METHODS OF JOINING

©2024 H-P Products

## To determine your part number when ordering:

Use **GAUGE**  
plus **PRODUCT ID**  
plus **MATERIAL TYPE**

GAUGE    PRODUCT ID    MATERIAL TYPE

**16 - 150252 - A**

### WE ALSO CARRY...

- Replacement Gaskets
- Gasket Protection
- Static Strips
- Nuts & Bolts

*Please Call for Assistance*

**Compression couplings are available with and without gasket protectors.**

### In the protector column:

11 = with gasket protector  
10 = no gasket protector

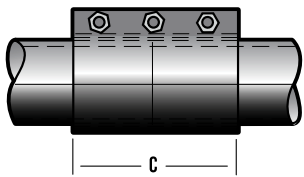

**COMPRESSION COUPLING**

Additional sizes available upon request

### TERMINOLOGY

CLR	Center Line Radius
ERW	Electric Resistance Welded
FNPT	Female National Pipe Thread
ID	Inside Diameter
MNPT	Male National Pipe Thread
NPS	Nominal Pipe Size
OD	Outside Diameter
SCH	Schedule

## COMPRESSION COUPLINGS

SIZE	ID	NPS SIZE	METRIC	PRODUCT ID	BOLTS	GASKET	PROTECTOR	LENGTH
8'	8.000	.	203.2	8000	2	W	10	6
.	8.000	.	203.2	8000	2	W	11	6
.	8.000	.	203.2	8000	3	B	10	8
.	8.000	.	203.2	8000	3	B	11	8
.	8.000	.	203.2	8000	3	R	10	8
.	8.000	.	203.2	8000	3	R	10	8
.	8.000	.	203.2	8000	3	W	11	8
.	8.000	.	203.2	8000	3	W	10	8
.	8.000	.	203.2	8000	4	B	11	10
.	8.000	.	203.2	8000	4	B	10	10
.	8.000	.	203.2	8000	4	R	11	10
.	8.000	.	203.2	8000	4	R	10	10
.	8.000	.	203.2	8000	4	W	11	10
.	8.000	.	203.2	8000	4	W	10	10
.	8.000	.	203.2	8000	5	B	11	12
.	8.000	.	203.2	8000	5	B	10	12
.	8.000	.	203.2	8000	5	W	11	12
.	8.000	.	203.2	8000	5	W	10	12
8-5/8"	8.625	8	219.1	8625	3	B	10	8
.	8.625	8	219.1	8625	3	W	10	8
.	8.625	8	219.1	8625	3	B	10	8
.	8.625	8	219.1	8625	3	W	10	8
9"	9.000	.	228.6	9000	3	B	10	8
10"	10.000	254.0	10000	4500	3	B	10	8
.	10.000	254.0	10000	4500	3	B	11	8
.	10.000	254.0	10000	4500	3	R	10	8
.	10.000	254.0	10000	4500	3	R	11	8
.	10.000	254.0	10000	4500	3	W	10	8
.	10.000	254.0	10000	4500	3	W	11	8
.	10.000	254.0	10000	5000	4	B	10	10
.	10.000	254.0	10000	5000	4	B	11	10
.	10.000	254.0	10000	5000	4	R	10	10
.	10.000	254.0	10000	5000	4	R	11	10
.	10.000	254.0	10000	5000	4	W	10	10
.	10.000	254.0	10000	5000	4	w	11	10
.	10.000	254.0	10000	5000	5	W	10	12
12"	12.000	.	304.8	12000	3	B	10	8
.	12.000	.	304.8	12000	3	B	11	8
.	12.000	.	304.8	12000	3	W	10	8
.	12.000	.	304.8	12000	4	B	10	10
.	12.000	.	304.8	12000	4	B	11	10
.	12.000	.	304.8	12000	4	W	10	10
.	12.000	.	304.8	12000	4	W	11	10
.	12.000	5	304.8	12000	5	B	10	12
.	12.000	5	304.8	12000	5	B	11	12

# METHODS OF JOINING

All reference dimensions are nominal

## COMPRESSION COUPLINGS

SIZE	ID	NPS SIZE	METRIC	PRODUCT ID	BOLTS	GASKET	PROTECTOR	LENGTH
14"	14.000	.	355.6	14000	4	B	10	10
.	14.000	.	355.6	14000	4	B	11	10
.	14.000	.	355.6	14000	4	W	10	10
.	14.000	.	355.6	14000	4	W	11	10
.	14.000	.	355.6	14000	5	B	10	12

### Coupling Specifications

- ☑ 1-1/2" through 14" OD for tube
  - ☑ 1-1/2" through 8" NPS for pipe
  - ☑ Heavy 16 gauge outer shell on all couplings over 3-1/4" in diameter provides added strength and dimensional stability.
  - ☑ G90 galvanized exterior coating provides superior corrosion resistance.
  - ☑ Reinforcement bars are zinc plated steel to provide additional strength and stability.
  - ☑ Grade 5 stress relieved bolts ensure durability.
  - ☑ Industry compatible, precision die cut black neoprene gasket ensures a tight seal.
  - ☑ Stainless steel strip guards against static electricity build-up.
- Stainless steel compression couplings available upon request.*
- Stainless steel gasket protectors are also available.*

### Other gaskets:

White Nitrile  
Red Rubber  
Silicone  
EPDM  
Viton

### Call for information!

Catalog Part Variations Available Upon Request

**GIVE US A CALL IF YOU CAN'T FIND EXACTLY WHAT YOU NEED!**

# METHODS OF JOINING

©2024 H-P Products

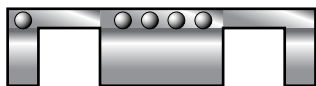

Length: 18" 3-Bolt 20" 4-Bolt

## Eliminator Specifications

The Eliminator, with its extra holding power, is ideal for higher pressure systems. Bands at either end of the Eliminator provide metal to metal "gripping" to eliminate end pull.

- ⊗ 2" to 12" OD for Tube
- ⊗ 2" to 12" NPS for Pipe
- ⊗ Standard gasket is black neoprene

Kits are available to convert existing couplings into eliminators (see next section)

## Other gaskets:

- White Nitrile
- Red Rubber
- Silicone
- EPDM
- Viton

Call for information!

### TERMINOLOGY

- CLR Center Line Radius
- ERW Electric Resistance Welded
- FNPT Female National Pipe Thread
- ID Inside Diameter
- MNPT Male National Pipe Thread
- NPS Nominal Pipe Size
- OD Outside Diameter
- SCH Schedule

## ELIMINATORS

Order by  
Product ID Number Only

OD	NPS	LENGTH	BOLTS	GASKET	PRODUCT ID
2"	.	18"	3	Black Gasket	20003B10EL
2"	.	18"	3	White Gasket	20003W10EL
2-3/8"	2"	18"	3	Pipe Black Gasket	23753B10EL
2-3/8"	2"	18"	3	Pipe White Gaske	23753W10EL
2-1/2"	.	18"	3	Black Gasket	25003B10EL
2-1/2"	.	18"	3	White Gaske	25003W10EL
2-7/8"	2-1/2"	18"	3	Pipe Black Gasket	28753B10EL
2-7/8"	2-1/2"	18"	3	Pipe White Gasket	28753W10EL
3"	.	18"	3	Black Gasket	30003B10EL
3"	.	18"	3	White Gasket	30003W10EL
3"	.	20"	4	Black Gasket	30004B10EL
3"	.	20"	4	White Gasket	30004W10EL
3-1/2"	3"	18"	3	Tube/Pipe Black Gasket	35003B10EL
3-1/2"	3"	18"	3	Tube/Pipe White Gasket	35003W10EL
3-1/2"	3"	20"	4	Tube/Pipe Black Gasket	35004B10EL
3-1/2"	3"	20"	4	Tube/Pipe White Gasket	35004W10EL
4"	3-1/2"	18"	3 5"	Black Gasket	40003B10EL
4"	3-1/2"	18"	3 5"	White Gasket	40003W10EL
4"	3-1/2"	20"	4 5"	Black Gasket	40004B10EL
4"	3-1/2"	20"	3 5"	White Gasket	40004W10EL
4-1/2"	4"	18"	3 5"	Pipe Black Gasket	45003B10EL
4-1/2"	4"	18"	4 5"	Pipe White Gasket	45003W10EL
4-1/2"	4"	20"	4 5"	Pipe Black Gasket	45004B10EL
4-1/2"	4"	20"	3	Pipe White Gasket	45004W10EL
5"	.	18"	3	Black Gasket	50003B10EL
5"	.	18"	4	White Gasket	50003W10EL
5"	.	20"	4	White Gasket	50004W10EL
5-9/16"	5"	18"	3	Pipe Black Gasket	55633B10EL
5-9/16"	5"	18"	3	Pipe White Gasket	55633W10EL
5-9/16"	5"	20"	4	Pipe Black Gasket	55634B10EL
5-9/16"	5"	20"	4	Pipe White Gasket	55634W10EL
6"	.	18"	3	Black Gasket	60003B10EL
6"	.	18"	3	White Gasket	60003W10EL
6"	.	20"	4	Black Gasket	60004B10EL
6"	.	20"	4	White Gaske	60004W10EL
6-5/8"	6"	18"	3	Pipe Black Gasket	66253B10EL
6-5/8"	6"	18"	3	Pipe White Gasket	66253W10EL
6-5/8"	6"	20"	4	Pipe Black Gasket	66254B10EL
6-5/8"	6"	20"	4	Pipe White Gasket	66254W10EL
8"	.	18"	3	Black Gasket	80003B10EL
8"	.	18"	3	White Gasket	80003W10EL
8"	.	20"	4	Black Gasket	80004B10EL
8"	.	20"	4	White Gasket	80004W10EL
8-5/8"	8"	18"	3	Pipe Black Gasket	86253B10EL

# METHODS OF JOINING

All reference dimensions are nominal

## ELIMINATORS

Order by  
Product ID Number Only

OD	NPS	LENGTH	BOLTS	GASKET	PRODUCT ID
8-5/8"	8"	18"	3	Pipe White Gasket	86253W10EL
8-5/8"	8"	20"	4	Pipe Black Gasket	86254B10EL
8-5/8"	8"	20"	4	Pipe White Gasket	86254W10EL
10"	2"	18"	3	Black Gasket	100003B10EL
10"	.	18"	3	White Gasket	100003W10EL
10"	.	20"	4	Black Gasket	100004B10EL
10"	.	20"	4	White Gasket	100004W10EL
10-3/4"	10"	18"	3	Pipe Black Gasket	107503B10EL
10-3/4"	10"	18"	3	Pipe White Gasket	107503W10EL
10-3/4"	10"	20"	4	Pipe Black Gasket	107504B10EL
10-3/4"	10"	20"	4	Pipe White Gasket	107504W10EL
12"	.	18"	3	Black Gasket	120003B10EL
12"	.	18"	3	White Gasket	120003W10EL
12"	.	20"	4	White Gasket	120004W10EL
12"	.	20"	4	Black Gasket	120004B10EL
12-3/4"	12"	18"	3	Pipe Black Gasket	127503B10EL
12-3/4"	12"	18"	3	Pipe White Gasket	127503W10EL
12-3/4"	12"	20"	4	Pipe Black Gasket	127504B10EL
12-3/4"	12"	20"	4	Pipe White Gasket	127504W10EL

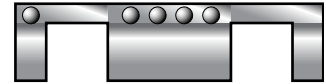

Length: 18" 3-Bolt 20" 4-Bolt

### Eliminator Specifications

The Eliminator, with its extra holding power, is ideal for higher pressure systems. Bands at either end of the Eliminator provide metal to metal "gripping" to eliminate end pull.

- ⊗ 2" to 12" OD for Tube
- ⊗ 2" to 12" NPS for Pipe
- ⊗ Standard gasket is black neoprene

Kits are available to convert existing couplings into eliminators (see next section)

### Other gaskets:

White Nitrile  
Red Rubber  
Silicone  
EPDM  
Viton

Call for information!

# METHODS OF JOINING

©2024 H-P Products

## Eliminator Specifications

Eliminator Kits are used to convert existing compression couplings into eliminators. This conversion, when complete, gives you the same benefits as our Standard Eliminators.

Call for information!

## ELIMINATOR KITS

Order by  
Product ID Number Only

OD	NPS	LENGTH	BOLTS	PRODUCT ID
2"	.	18"	3	20003ELK
2-3/8"	2"	18"	3	23753ELK
2-1/2"	.	18"	3	25003ELK
2-7/8"	2-1/2"	18"	3	28753ELK
3"	.	18"	3	30003ELK
3"	.	20"	4	30004ELK
3-1/2"	3"	18"	3	35003ELK
3-1/2"	3"	20"	4	35004ELK
4"	3-1/2"	18"	3	40003ELK
4"	3-1/2"	20"	4	40004ELK
4-1/2"	4"	18"	3	45003ELK
4-1/2"	4"	20"	4	45004ELK
5"	.	18"	3	50003ELK
5"	.	20"	4	50004ELK
5-9/16"	5"	18"	3	55633ELK
5-9/16"	5"	20"	4	55634ELK
6"	.	18"	3	60003ELK
6"	.	20"	4	60004ELK
6-5/8"	6"	18"	3	66253ELK
6-5/8"	6	20"	4	66254ELK
8"	.	18"	3	80003ELK
8"	.	20"	4	80004ELK
8-5/8"	8"	18"	3	86253ELK
8-5/8"	8	20"	4	86254ELK
10"	.	18"	3	100003ELK
10"	.	20"	4	100004ELK
10-3/4"	10"	18"	3	107503ELK
10-3/4"	10"	20"	4	107504ELK
12"	.	18"	3	120003ELK
12"	.	20"	4	120004ELK
12-3/4"	12"	18"	3	127503ELK
12-3/4"	12"	20"	4	127504ELK

## TERMINOLOGY

CLR	Center Line Radius
ERW	Electric Resistance Welded
FNPT	Female National Pipe Thread
ID	Inside Diameter
MNPT	Male National Pipe Thread
NPS	Nominal Pipe Size
OD	Outside Diameter
SCH	Schedule

# METHODS OF JOINING

All reference dimensions are nominal

## SUPER GRIPS

Order by  
Product ID Number Only

OD	NPS	LENGTH	GASKET	PRODUCT ID
1-1/2"	.	4"	1-Clamp	SG-15001
1-21/32"	1-1/4"	4"	Pipe 1-Clamp	SG-16601
1-3/4"	.	4"	1-Clamp	SG-17501
1-29/32"	1-1/2"	4"	Pipe 1-Clamp	SG-19001
2"	.	4"	1-Clamp	SG-20001
2-1/8"	.	4"	1-Clamp	SG-21251
2-1/4"	.	4"	1-Clamp	SG-22501
2-3/8"	2"	4"	Pipe 1-Clamp	SG-23751
2-1/2"	.	4"	1-Clamp	SG-25001
2-3/4"	.	4"	1-Clamp	SG-27501
2-7/8"	2-1/2"	4"	Pipe 1-Clamp	SG-28751
3"	.	4"	1-Clamp	SG-30001
3-1/4"	.	4"	1-Clamp	SG-32501
3-1/2"	3"	4"	Tube/Pipe 1-Clamp	SG-35001
3-3/4"	.	4"	1-Clamp	SG-37501
4"	3-1/2"	4"	Tube/Pipe 1-Clamp	SG-40001
4"	3-1/2"	9-1/2"	Tube/Pipe 2-Clamp	SG-40002
4-1/4"	.	4"	1-Clamp	SG-42501
4-1/2"	4"	4"	Tube/Pipe 1-Clamp	SG-45001
4-1/2"	4"	9-1/2"	Tube/Pipe 2-Clamp	SG-45002
5"	.	4"	1-Clamp	SG-50001
5"	.	9-1/2"	2-Clamp	SG-50002
5-9/16"	5"	4"	Pipe 1-Clamp	SG-55631
6"	.	4"	1-Clamp	SG-60001
6"	.	9-1/2"	2-Clamp	SG-60002
6-1/4"	.	4"	1-Clamp	SG-62501
6-5/8"	6"	4"	Pipe 1-Clamp	SG-66251
6-5/8"	6"	9-1/2"	Pipe 2-Clamp	SG-66252
8"	.	4"	1-Clamp	SG-80001
8"	.	9-1/2"	2-Clamp	SG-80002
8-5/8"	8"	4"	Pipe 1-Clamp	SG-86251
8-5/8"	8"	9-1/2"	Pipe 1-Clamp	SG-86252
9"	.	4"	1-Clamp	SG-90001
10"	.	4"	1-Clamp	SG-100001
10"	.	9-1/2"	2-Clamp	SG-100002
10-3/4"	10"	4"	Pipe 1-Clamp	SG-107501
10-3/4"	10"	9-1/2"	Pipe 2-Clamp	SG-107502
12"	.	4"	1-Clamp	SG-120001
12"	.	9-1/2"	2-Clamp	SG-120002
12-3/4"	12"	4"	Pipe 1-Clamp	SG-127501
12-3/4"	12"	9-1/2"	Pipe 2-Clamp	SG-127502

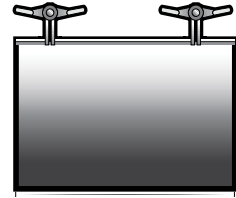

4" lengths are single handle  
9-1/2" lengths are 2 handle

### Super Grip Specifications

The Super Grip was devised as a quick coupler for dry bulk transport tank tubing. This unique coupling slides onto the tubing or wraps around it and is tightened by hand in seconds, and it provides better support than rubber hose and band clamps. Our exclusive failsafe clamping action keeps its hold despite expansion, contraction and vibration. And because it's made of 100% Stainless Steel, it will not corrode due to harsh weather or road conditions.

- ⊙ 100% Stainless steel with stainless steel grounding strip standard
- ⊙ FDA approved gum rubber gasket comes standard
- ⊙ 1-1/2" Through 12" OD for tube
- ⊙ 1-1/4" Through 12" NPS for pipe

Call for information!

# METHODS OF JOINING

©2024 H-P Products

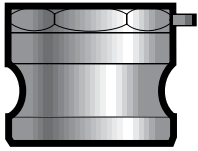

**Part F - Adapter X Male NPT Thread**

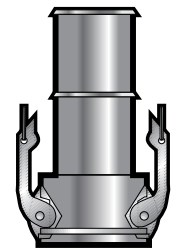

**Part W - Coupler X Adapter Dust Plug**

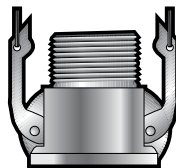

**Part F - Adapter X Male NPT Thread**

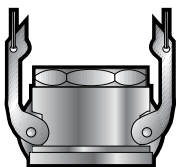

**Part W - Coupler X Adapter Dust Plug**

## TERMINOLOGY

CLR	Center Line Radius
ERW	Electric Resistance Welded
FNPT	Female National Pipe Thread
ID	Inside Diameter
MNPT	Male National Pipe Thread
NPS	Nominal Pipe Size
OD	Outside Diameter
SCH	Schedule

Order by Product ID Number

## STANDARD PART A

Adapter X Female NPT Thread

OD	MATERIAL	WEIGHT	PRODUCT ID
1-1/2"	Aluminum	0.25	A150FAL
1-1/2"	Stainless Steel	0.81	A150FSS
2"	Aluminum	0.37	A200FAL
2"	Stainless Steel	1.06	A200FSS
2-1/2"	Aluminum	0.56	A250FAL
2-1/2"	Stainless Steel	1.56	A250FSS
3"	Aluminum	0.75	A300FAL
3"	Stainless Steel	2.0	A300FSS
4"	Aluminum	1.56	A400FAL
4"	Stainless Steel	4.12	A400FSS
5"	Aluminum	1.81	A500FAL
6"	Aluminum	2.44	A600FAL

## STANDARD PART B

Coupler X Male NPT Thread

OD	MATERIAL	WEIGHT	PRODUCT ID
1-1/2"	Aluminum	0.75	B150FAL
1-1/2"	Stainless Steel	1.56	B150FSS
2"	Aluminum	0.94	B200FAL
2"	Stainless Steel	2.06	B200FSS
2-1/2"	Aluminum	1.25	B250FAL
2-1/2"	Stainless Steel	2.94	B250FSS
3"	Aluminum	1.75	B300FAL
3"	Stainless Steel	4	B300FSS
4"	Aluminum	2.5	B400FAL
4"	Stainless Steel	6.5	B400FSS
5"	Aluminum	3.75	B500FAL
6"	Aluminum	5.37	B600FAL

## STANDARD PART C

Coupler X Hose Shank

OD	MATERIAL	WEIGHT	PRODUCT ID
1-1/2"	Aluminum	0.78	C150FAL
1-1/2"	Stainless Steel	1.84	C150FSS
2"	Aluminum	1.16	C200FAL
2"	Stainless Steel	2.31	C200FSS
2-1/2"	Aluminum	1.56	C250FAL
2-1/2"	Stainless Steel	3.12	C250FSS
3"	Aluminum	2	C300FAL
3"	Stainless Steel	4.87	C300FSS
4"	Aluminum	3.37	C400FAL
4"	Stainless Steel	8.25	C400FSS
5"	Aluminum	4.19	C500FAL
6"	Aluminum	6.06	C600FAL

## STANDARD PART D

Coupler X Female NPT Thread

OD	MATERIAL	WEIGHT	PRODUCT ID
1-1/2"	Aluminum	0.84	D150FAL
1-1/2"	Stainless Steel	1.81	D150FSS
2"	Aluminum	1	D200FAL
2"	Stainless Steel	2.37	D200FSS
2-1/2"	Aluminum	1.41	D250FAL
2-1/2"	Stainless Steel	3.16	D250FSS
3"	Aluminum	1.78	D300FAL
3"	Stainless Steel	4.09	D300FSS
4"	Aluminum	2.81	D400FAL
4"	Stainless Steel	7	D400FSS
5"	Aluminum	4.37	D500FAL
6"	Aluminum	6	D600FAL

## Adapter & Coupler Specifications

- 1-1/2" through 6"
- Aluminum & Stainless
- 8" available upon request

Security chains available  
Other sizes and materials available.

Call for information!



# METHODS OF JOINING

All reference dimensions are nominal

Order by Product ID Number

## STANDARD PART E

Adapter X Hose Shank

OD	MATERIAL	WEIGHT	PRODUCT ID
1-1/2"	Aluminum	0.37	E150FAL
1-1/2"	Stainless Steel	1.65	E150FSS
2"	Aluminum	0.84	E200FAL
2"	Stainless Steel	2.75	E200FSS
2-1/2"	Aluminum	0.91	E250FAL
2-1/2"	Stainless Steel	3.5	E250FSS
3"	Aluminum	1.47	E300FAL
3"	Stainless Steel	4.06	E300FSS
4"	Aluminum	2.5	E400FAL
4"	Stainless Steel	7.81	E400FSS
5"	Aluminum	2.69	E500FAL
6"	Aluminum	4.56	E600FAL

## STANDARD PART F

Adapter X Male NPT Thread

OD	MATERIAL	WEIGHT	PRODUCT ID
1-1/2"	Aluminum	0.5	F150FAL
1-1/2"	Stainless Steel	1.28	F150FSS
2"	Aluminum	0.53	F200FAL
2"	Stainless Steel	1.75	F200FSS
2-1/2"	Aluminum	0.81	F250FAL
2-1/2"	Stainless Steel	3.25	F250FSS
3"	Aluminum	1.37	F300FAL
3"	Stainless Steel	4.5	F300FSS
4"	Aluminum	2.28	F400FAL
4"	Stainless Steel	7	F400FSS
5"	Aluminum	2.72	F500FAL
6"	Aluminum	4.31	F600FAL

## STANDARD PART V

Coupler Dust Cap

OD	MATERIAL	WEIGHT	PRODUCT ID
1-1/2"	Aluminum	0.81	V150FAL
1-1/2"	Stainless Steel	1.5	V150FSS
2"	Aluminum	0.94	V200FAL
2"	Stainless Steel	2.06	V200FSS
2-1/2"	Aluminum	1.19	V250FAL
2-1/2"	Stainless Steel	2.84	V250FSS
3"	Aluminum	1.78	V300FAL
3"	Stainless Steel	3.75	V300FSS
4"	Aluminum	2.5	V400FAL
4"	Stainless Steel	5.31	V400FSS
5"	Aluminum	3.19	V500FAL
6"	Aluminum	5.19	V600FAL

## STANDARD PART W

Adapter Dust Plug

OD	MATERIAL	WEIGHT	PRODUCT ID
1-1/2"	Aluminum	0.22	W150FAL
1-1/2"	Stainless Steel	1	W150FSS
2"	Aluminum	0.34	W200FAL
2"	Stainless Steel	1.44	W200FSS
2-1/2"	Aluminum	0.44	W250FAL
2-1/2"	Stainless Steel	2	W250FSS
3"	Aluminum	0.87	W300FAL
3"	Stainless Steel	2.62	W300FSS
4"	Aluminum	1.37	W400FAL
4"	Stainless Steel	5.25	W400FSS
5"	Aluminum	1.5	W500FAL
6"	Aluminum	2.31	W600FAL

## Adapter & Coupler Specifications

- 1-1/2" through 6"
- Aluminum & Stainless
- 8" available upon request

Security chains available  
Other sizes and materials available.

Call for information!



**Part E  
Adapter X  
Hose Shank**

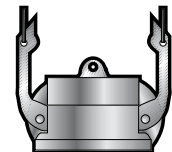

**Part V  
Coupler  
Dust Cap**



**Part F - Adapter X  
Male NPT Thread**

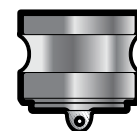

**Part W - Coupler X  
Adapter Dust Plug**

### WHY BUY OUR CAM & GROOVE PARTS?

- Pressure tested with published ratings
- Will handle full vacuum applications

All sizes, except 5" & 8" comply  
with MIL Spec A-A-59326

Compliance to this specification allows  
industry interchangeability

**PLEASE CALL  
FOR PRICING &  
INFORMATION!**

Catalog Part Variations Available Upon Request

**GIVE US A CALL IF YOU CAN'T FIND EXACTLY WHAT YOU NEED!**

# METHODS OF JOINING

©2024 H-P Products

## Compression Nut Quick Adapters & Couplers

- ⊗ Designed for quick assembly, with a compression nut, to 1-1/2 to 3" tubing.
- ⊗ Aluminum with Buna Gasket

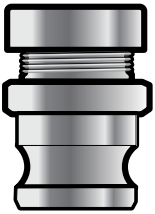

**Part FC Adapter**

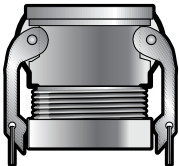

**Part BC Coupler**

Order by Product ID Number

## PART BC - COMPRESSION NUT QUICK COUPLERS

*Coupler X Tubing Fitting*

OD	MATERIAL	PRODUCT ID
1-1/2"	Aluminum	BC150AL
2"	Aluminum	BC200AL
2-1/2"	Aluminum	BC250AL
3"	Aluminum	BC300AL

## PART FC - COMPRESSION NUT QUICK ADAPTERS

*Adapter X Tubing Fitting*

OD	MATERIAL	PRODUCT ID
1-1/2"	Aluminum	FC150AL
2"	Aluminum	FC200AL
2-1/2"	Aluminum	FC250AL
3"	Aluminum	FC300AL

## SECURITY CHAINS

*Brass Chain With Hooks or Rings For Standard Cam & Groove*

Length	Weight	Type	Product ID
6"	0.25	Hook	BRCHAIN6H
6"	0.25	Ring	BRCHAIN6R
12"	0.5	Hook	BRCHAIN12H
12"	0.5	Ring	BRCHAIN12R

### TERMINOLOGY

CLR	Center Line Radius
ERW	Electric Resistance Welded
FNPT	Female National Pipe Thread
ID	Inside Diameter
MNPT	Male National Pipe Thread
NPS	Nominal Pipe Size
OD	Outside Diameter
SCH	Schedule

# METHODS OF JOINING

All reference dimensions are nominal

Order by Product ID Number

## TUBE QUICK ADAPTERS

OD	MATERIAL	PRODUCT ID
2"	16	AWS200AL-16A
2"	14	AWS200AL-14A
2"	11	AWS200AL-11A
2-1/2"	16	AWS250AL-16A
2-1/2"	14	AWS250AL-14A
2-1/2"	11	AWS250AL-11A
3"	16	AWS300AL-16A
3"	14	AWS300AL-14A
3"	11	AWS300AL-11A
4"	16	AWS400AL-16A
4"	14	AWS400AL-14A
4"	11	AWS400AL-11A
5"	14	AWS500AL-14A
5"	11	AWS500AL-11A
6"	14	AWS600AL-14A
6"	11	AWS600AL-11A

## PIPE QUICK ADAPTERS

OD	MATERIAL	PRODUCT ID
2"	10	AWSP200AL-10A
2"	40	AWSP200AL-40A
3"	10	AWSP300AL-10A
3"	40	AWSP300AL-40A
4"	10	AWSP400AL-10A
4"	40	AWSP400AL-40A
5"	10	AWSP500AL-10A
5"	40	AWSP500AL-40A
6"	10	AWSP600AL-10A
6"	40	AWSP600AL-40A

## TUBE QUICK COUPLERS

OD	MATERIAL	PRODUCT ID
2"	16	DWS200AL-16A
2"	14	DWS200AL-14A
2"	11	DWS200AL-11A
2-1/2"	16	DWS250AL-16A
2-1/2"	14	DWS250AL-14A
2-1/2"	11	DWS250AL-11A
3"	16	DWS300AL-16A
3"	14	DWS300AL-14A
3"	11	DWS300AL-11A
4"	16	DWS400AL-16A
4"	14	DWS400AL-14A
4"	11	DWS400AL-11A
5"	14	DWS500AL-14A
5"	11	DWS500AL-11A
6"	14	DWS600AL-14A
6"	11	DWS600AL-11A

## PIPE QUICK COUPLERS

OD	MATERIAL	PRODUCT ID
2"	10	DWSP200AL-10A
2"	40	DWSP200AL-40A
3"	10	DWSP300AL-10A
3"	40	DWSP300AL-40A
4"	10	DWSP400AL-10A
4"	40	DWSP400AL-40A
5"	10	DWSP500AL-10A
5"	40	DWSP500AL-40A
6"	10	DWSP600AL-10A
6"	40	DWSP600AL-40A

### Specifications

Our Quick Adapter (AWS) and Coupler (DWS) are welded to a short length of tube or pipe for easy installation or dismantling.

- ⊗ 2" through 6" OD, 16, 14, 11 Gauge Stubs
- ⊗ 2" through 6" NPS, Schedule 10, 40 Stubs (SCH 5 available)
- ⊗ Aluminum

Security chains available

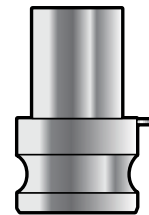

**Part AWS Adapter**

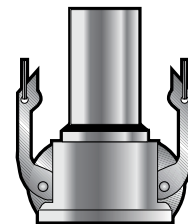

**Part DWS Coupler**

Catalog Part Variations Available Upon Request

**GIVE US A CALL IF YOU CAN'T FIND EXACTLY WHAT YOU NEED!**

# ACCESSORIES

©2024 H-P Products

## Wand Specifications

- Adjustable air relief is constructed of durable PVC
- Premium wands comewith handles and end protectors
- Sizes range from 1-1/2" OD to 4" OD
- Available in Aluminum and Stainless Steel

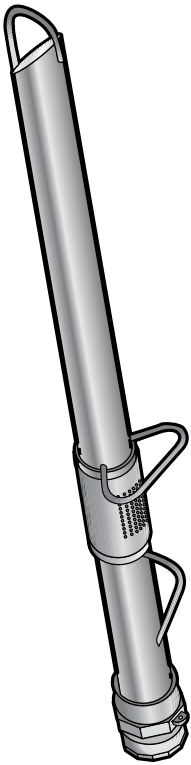

### TERMINOLOGY

- CLR Center Line Radius
- ERW Electric Resistance Welded
- FNPT Female National Pipe Thread
- ID Inside Diameter
- MNPT Male National Pipe Thread
- NPS Nominal Pipe Size
- OD Outside Diameter
- SCH Schedule

Order by Product ID Number

## PREMIUM VACUUM GAYLORD WANDS

*Without Cam and Groove Coupling*

OD	GAUGE	LENGTH	MATERIAL	PRODUCT ID
1-1/2"	11	51"	Aluminum	11VW150A
1-1/2"	14	51"	Stainless	14VW150S
2"	11	51"	Aluminum	11VW200A
2"	14	51"	Stainless	14VW200S
2-1/2"	11	51"	Aluminum	11VW250A
2-1/2"	14	51"	Stainless	14VW250S
3"	11	51"	Aluminum	11VW300A
3"	14	51"	Stainless	14VW300S
4"	11	51"	Aluminum	11VW400A
4"	14	51"	Stainless	14VW400S

*With Cam and Groove Coupling*

OD	GAUGE	LENGTH	MATERIAL	PRODUCT ID
1-1/2"	11	57	Aluminum	11VW150A - CG
1-1/2"	14	57	Stainless	14VW150S - CG
2"	11	57	Aluminum	11VW200A - CG
2"	14	57	Stainless	14VW200S - CG
2-1/2"	11	57	Aluminum	11VW250A - CG
2-1/2"	14	57	Stainless	14VW250S - CG
3"	11	57	Aluminum	11VW300A - CG
3"	14	57	Stainless	14VW300S - CG
4"	11	57	Aluminum	11VW400A - CG
4"	14	57	Stainless	14VW400S - CG

## BASIC VACUUM GAYLORD WANDS

OD	GAUGE	LENGTH	MATERIAL	PRODUCT ID
1-1/2"	11	50"	Aluminum	11VWB150A
2"	11	50"	Aluminum	11VWB200A
2-1/2"	11	50"	Aluminum	11VWB250A
3"	11	50"	Aluminum	11VWB300A

# ACCESSORIES

All reference dimensions are nominal

Order by Product ID Number

## \*TUBE SIGHT GLASSES

OD	GAUGE	TUBE ENDS	PRODUCT ID
1-1/2"	16	Aluminum	150016ALUSG
2"	16	Aluminum	200016ALUSG
2"	11	Aluminum	200011ALUSG
2-1/4"	16	Aluminum	225016ALUSG
2-1/2"	16	Aluminum	250016ALUSG
2-1/2"	11	Aluminum	250011ALUSG
3"	16	Aluminum	300016ALUSG
3"	11	Aluminum	300011ALUSG
3-1/2"	16	Aluminum	350016ALUSG
3-1/2"	11	Aluminum	350011ALUSG
4"	16	Aluminum	400016ALUSG
4"	11	Aluminum	400011ALUSG
4-1/2"	16	Aluminum	450016ALUSG
4-1/2"	11	Aluminum	450011ALUSG
5"	14	Aluminum	500014ALUSG
5"	11	Aluminum	500011ALUSG
6"	11	Aluminum	600011ALUSG

\*NOT RECOMMENDED FOR APPLICATIONS OVER 180 ° (F)

## \*PIPE SIGHT GLASSES

OD	GAUGE	TUBE ENDS	PRODUCT ID
2"	40	Aluminum	200040APUSG
2"	40	Carbon	200040CSUSG
2-1/2"	40	Aluminum	250040APUSG
2-1/2"	40	Carbon	250040CSUSG
3"	40	Aluminum	300040APUSG
3"	40	Carbon	300040CSUSG
3-1/2"	40	Aluminum	350040APUSG
3-1/2"	40	Carbon	350040CSUSG
4"	40	Aluminum	400040APUSG
4"	40	Carbon	400040CSUSG
5"	40	Aluminum	500040APUSG
5"	40	Carbon	500040CSUSG
6"	40	Aluminum	600040APUSG
6"	40	Carbon	600040CSUSG

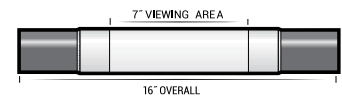

### Sight Glasses

The Acrylic Sight Glass (ASG) allows you to see at a glance the material flowing through your conveying system. It's precision made by aligning the acrylic with the tube or pipe to insure smooth material flow with no turbulence. A stainless steel ground strip is included to eliminate static build up. The ASG is easy to install in new or existing lines by using two Couplings.

- ☉ Tube or pipe ends are made of carbon steel or aluminum. Stainless or Galvanized are available upon request.
- ☉ Wall Thickness:  
 Tube - 16, 14 & 11 Gauge  
 Pipe - Schedule 5, 10, 40 & 80
- ☉ Overall Length is 16"
- ☉ 7" Viewing Area

**Special sight glasses are available upon request**

# ACCESSORIES

All reference dimensions are nominal

## METAL FLEXIBLE HOSE

Please call with specifications and we'll be happy to quote!

*Here is the information we will need to accurately quote metal flex hose:*

- ⊗ Size (ID)
- ⊗ Temperature required
- ⊗ Application
- ⊗ Material conveyed
- ⊗ Pressure
- ⊗ End treatments
- ⊗ Direction of material flow

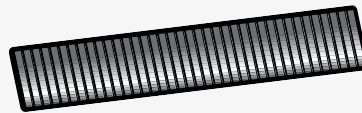

## Specifications

- ⊗ 1-1/2" - 14" ID sizes are made from stainless or galvanized steel
- ⊗ Variety of material thicknesses are available
- ⊗ Unlined (rough bore) or lined (smooth bore)
- ⊗ Packing options include cotton, stainless steel wire, apyrrous, elastomeric (gas tight) and silicone
- ⊗ We offer a wide selection of end fittings, including Cam & Groove, Flanges, Tube Stubs and Pipe Nipples
- ⊗ Raw coils available in multiples of 25'; shorter lengths available as custom assemblies

## PVC Specifications

- ⊗ Counter clockwise spiral
- ⊗ Service temp. Range:  
-4°F to 150° F

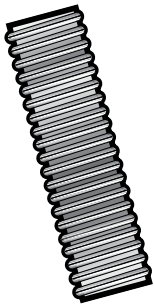

Order by Product ID Number

Standard Duty

## PVC CLEAR FOOD GRADE HOSE

ID	STD LENGTH (FT)	WEIGHT PER FOOT (LBS/FT)	TOTAL WEIGHT (LBS)	PRODUCT ID
1-1/2"	100	0.32	32	EHC150-100
1-1/2"	25	0.32	8	EHC150-25
2"	100	0.50	50	EHC200-100
2"	125	0.50	12.5	EHC200-25
2-1/2"	100	0.73	73	EHC250-100
2-1/2"	25	0.73	18.25	EHC250-25
3"	100	1.04	104	EHC300-100
3"	25	1.04	26	EHC300-25
4"	100	1.65	165	EHC400-100
4"	10	1.65	16.5	EHC400-10

Standard Duty

## PVC CLEAR FOOD GRADE HOSE

With Static Wire

ID	STD LENGTH (FT)	WEIGHT PER FOOT (LBS/FT)	TOTAL WEIGHT (LBS)	PRODUCT ID
1-1/2"	100	0.31	31	EHCE150-100
1-1/2"	25	0.31	7.75	EHCE150-25
2"	100	0.60	60	EHCE200-100
2"	125	0.60	15	EHCE200-25
2-1/2"	100	0.73	73	EHCE250-100
2-1/2"	25	0.73	18.25	EHCE250-25
3"	100	1.02	102	EHCE300-100
3"	25	1.02	25.5	EHCE300-25
4"	100	1.77	177	EHCE400-100
4"	10	1.77	17.7	EHCE400-10

### TERMINOLOGY

- CLR Center Line Radius
- ERW Electric Resistance Welded
- FNPT Female National Pipe Thread
- ID Inside Diameter
- MNPT Male National Pipe Thread
- NPS Nominal Pipe Size
- OD Outside Diameter
- SCH Schedule

# ACCESSORIES

All reference dimensions are nominal

Order by Product ID Number

Heavy Duty

## PVC CLEAR FOOD GRADE HOSE

ID	STD LENGTH (FT)	WEIGHT PER FOOT (LBS/FT)	TOTAL WEIGHT (LBS)	PRODUCT ID
1-1/2"	50	0.35	17.5	WT150-50
1-1/2"	100	0.35	35.0	WT150-100
2"	50	0.56	28.0	WT200-50
2"	100	0.56	56.0	WT200-100
2-1/2"	50	0.77	38.5	WT250-50
2-1/2"	100	0.77	77.0	WT250-100
3"	50	1.1	55.0	WT300-50
3"	100	1.1	110.0	WT300-100
3-1/2"	50	1.4	70.0	WT350-50
3-1/2"	100	1.4	140.0	WT350-100
4"	50	1.8	90.0	WT400-50
4"	100	1.8	180.0	WT400-100
5"	20	2.36	47.2	WT500-20
5"	100	2.36	236.0	WT500-100
6"	20	3.54	70.8	WT600-20
6"	50	3.54	177.0	WT600-50
6"	100	3.54	354.0	WT600-100
8"	20	5.1	102.0	WT800-20

Heavy Duty

## PVC CLEAR FOOD GRADE HOSE

With Static Wire

ID	STD LENGTH (FT)	WEIGHT PER FOOT (LBS/FT)	TOTAL WEIGHT (LBS)	PRODUCT ID
1-1/2"	50	0.43	25.8	WE150-50
2"	50	0.58	34.8	WE200-50
2-1/2"	50	0.88	52.8	WE250-50
3"	50	1.25	75	WE300-50
4"	50	1.93	115.8	WE400-50
5"	20	2.4	48	WE500-20
5"	60	2.4	144	WE500-60
6"	20	3.7	74	WE600-20
6"	60	3.7	222	WE600-60

## DOUBLE BOLT CLAMPS

Counter clockwise spiral for use on PVC hose

FITS HOSE ID	WEIGHT	PRODUCT ID
1-1/2"	0.18	SDBC150
2"	0.36	SDBC200
2-1/2"	0.48	SDBC250
3"	0.66	SDBC300
4"	1.02	SDBC400
5"	1.76	SDBC500
6"	2.00	SDBC600
8"	2.76	SDBC800

## PVC Specifications

- ⊗ Counter clockwise spiral
- ⊗ Service temp. Range: -4°F to 150° F

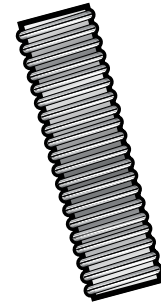

## Clamp Specifications

- ⊗ 1-1/2" Through 8"
- ⊗ Zinc-coated (galvanized)
- ⊗ For use on counterclockwise spiral, PVC hose

Note: two clamps are recommended for each end on 5" ID hose and larger

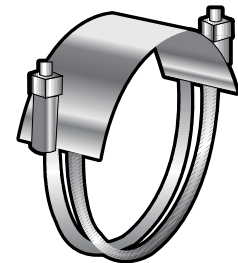

Catalog Part Variations Available Upon Request

**GIVE US A CALL IF YOU CAN'T FIND EXACTLY WHAT YOU NEED!**



Order by Product ID Number

H-P Products gives you everything you need to get your system up and running, all in one complete installation package. If you're searching for a particular installation component, we'll be glad to help you find whatever you're looking for. Our "one-stop-shopping" will help you lower your inventory costs and spend less time looking for parts. And, when it's time for installation, you'll have all the components you need on-the-spot.

DESCRIPTION	SIZE	MATERIAL	PKGD	PRODUCT ID
<b>Anchor, Hilti®</b>	3/8" x 1-9/16" (Length)	Zinc	50 pc	ANC-0380
<b>Bolt Anchor,</b>	3/8" x 3-3/4" (Overall Length)	Zinc	100 pc.	ANC-0381
Includes Washer and Hex Nut	0.66			
<i>Features: Comprehensive performance testing in concrete, lightweight concrete, and grout-filled block base materials. Can be installed in a bottomless hole. Anchor size is same as hole size for easy installation. Hilti® Kwik Bolt II Stud Anchor System.</i>				
<b>Hex Head Cap Screw</b> "More Length When You Need It"	3/8" x 1-1/4" (Length)	Zinc	50 pc.	HCS-0381
<b>Hex Nut</b>	3/8"	Zinc	50 pc.	HXN-0380
<b>Flat Washer</b>	3/8"	Zinc	50 pc.	FW-0380
<b>Split Lock Washer</b>	3/8"	Zinc	50 pc.	LKW-0380
<b>Threaded Rod</b>	3/8" x 6' (Length)	Zinc	50 pc.	ATR-100
<b>Eye Nut,</b> Maximum Allowable Load is 610 lbs. "Works Great With our Tube Hang-ers"	3/8" Tapped Hole	Malleable Iron - Plain.	50 pc.	EN-0380
<b>Coupler Nut</b>	3/8" x 1-3/4" (Length)	Zinc	50 pc.	FW-0380
<b>Beam Clamp</b> with Zinc Set Screw and Lock Nut. Maximum Allowable Load, in top or bottom position, is 550 lbs.	3/8" Tapped Hole	Malleable Iron - Galv.	50 pc.	FW-0380
<b>Beam Clamp</b> with Set Screw and Lock Nut.	3/8" Tapped Hole	Malleable Iron - Plain	50 pc.	FW-0380

Maximum Allowable Load, in top position, is 500 lbs.; in bottom position, 250 lbs.

"The Cost-Effective Solution When You Don't Need Our Heavy-Duty Beam Clamp (BC-037T)"

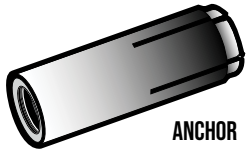

ANCHOR

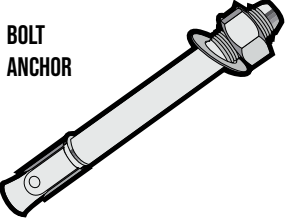

BOLT ANCHOR



HEX HEAD CAP SCREW

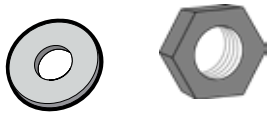

FLAT WASHER



SPLIT LOCK WASHER

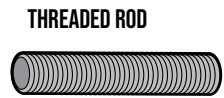

THREADED ROD

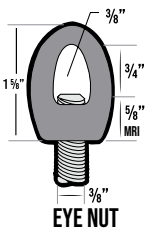

EYE NUT

**TERMINOLOGY**

- CLR Center Line Radius
- ERW Electric Resistance Welded
- FNPT Female National Pipe Thread
- ID Inside Diameter
- MNPT Male National Pipe Thread
- NPS Nominal Pipe Size
- OD Outside Diameter
- SCH Schedule

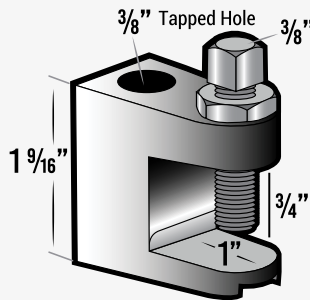

BEAM CLAMP

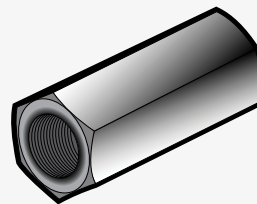

COUPLER NUT

Order by Product ID Number

DESCRIPTION	SIZE	MATERIAL	PKGD	PRODUCT ID
<b>Channel Nut</b> , without spring	3/8"	Zinc	each	CHN-0380
<b>Saddlenut Assembly</b> <i>"Replaces Square Washer Plate and a Channel Nut Combination"</i>		Zinc	25	SN-0380
<b>Slotted Strut, 14 Gauge</b>	13/16"(D) x 1-5/8", 10' Length	Zinc	each	UN-100
<b>Slotted Strut, 14 Gauge</b> <i>"An Economical Alternative When You Don't Require Our Heavy-Duty Strut (UN-202)"</i>	1-5/8"(D) x 1-5/8", 10' Length	Zinc	each	UN-201
<b>Slotted Strut, 12 Gauge</b>	1-5/8"(D) x 1-5/8", 10' Length	Zinc	each	UN-202
<b>90° Strut Bracket</b>	2 x 2, 9/16" Holes	Zinc	each	BRKT-0900
<b>90° Strut Bracket</b>	2 x 1, 9/16" Holes	Zinc	each	BRKT-0901
<b>45° Strut Bracket</b>	9/16" Holes	Zinc	each	BRKT-0450
<b>Square Washer Plate</b>	7/16" Hole for 3/8" Bolt Size	Zinc	100 pc.	SQW-0380
<b>Tube Hanger</b> , includes Bolt and Nut	For 1-1/2" OD Tube	Zinc	each	TH-150
<b>Tube Hanger</b> , includes Bolt and Nut	For 2" OD Tube	Zinc	each	TH-200
<b>Tube Hanger</b> , includes Bolt and Nut	For 2-1/8" and 2-1/4" OD Tube	Zinc	each	TH-212
<b>Tube Hanger</b> , includes Bolt and Nut	For 2-1/2" OD Tube	Zinc	each	TH-250
<b>Tube Hanger</b> , includes Bolt and Nut	For 3" OD Tube	Zinc	each	TH-300
<b>Tube Hanger</b> , includes Bolt and Nut	For 3-1/2" OD Tube	Zinc	each	TH-350
<b>Tube Hanger</b> , includes Bolt and Nut	For 4" OD Tube	Zinc	each	TH-400
<b>Tube Hanger</b> , includes Bolt and Nut	For 4-1/2" OD Tube	Zinc	each	TH-450
<b>Tube Hanger</b> , includes Bolt and Nut	For 5" OD Tube	Zinc	each	TH-500
<b>Tube Hanger</b> , includes Bolt and Nut	For 6" OD Tube	Zinc	each	TH-600
<b>Tube Hanger</b> , includes Bolt and Nut	For 8" OD Tube	Zinc	each	TH-800
<b>Tube Hanger</b> , includes Bolt and Nut	For 10" OD Tube	Zinc	each	TH-1000
<b>Tube Hanger</b> , includes Bolt and Nut	For 12" OD Tube	Zinc	each	TH-1200
<b>Tube Hanger</b> , includes Bolt and Nut	For 14" OD Tube	Zinc	each	TH-1400



**CHANNEL NUT**

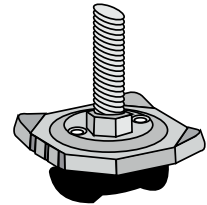

**SADDLE NUT ASSEMBLY**

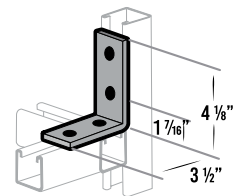

**90° STRUT BRACKET**  
2 HOLES X 2 HOLES

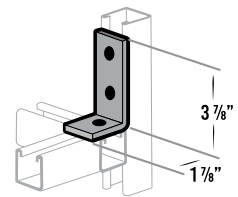

**90° STRUT BRACKET**  
2 HOLES X 1 HOLES

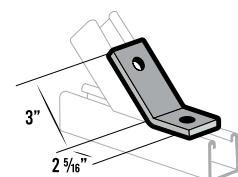

**45° STRUT BRACKET**  
1 HOLES X 1 HOLES

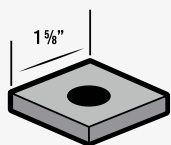

**SQUARE WASH  
PLATE**

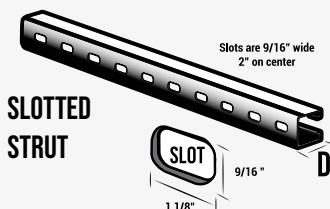

**SLOTTED  
STRUT**

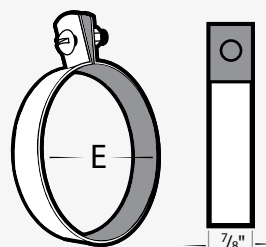

**STANDARD TUBE HANGER**

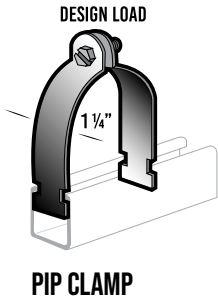

**NOTE:**  
 Tube Clamps are now available in 50 packs! To order, simply add 50 to the end of the Part Number!

Order by Product ID Number

DESCRIPTION	SIZE	MATERIAL	PKGD	PRODUCT ID
<b>Pipe Clamp</b> , includes Slotted Hex Head Screw and Nut, Design Load 800 lbs.	For 1-1/2" Pipe Size	Zinc	4 pc.	PCL-150
<b>Pipe Clamp</b> , includes Slotted Hex Head Screw and Nut, Design Load 800 lbs.	For 2" Pipe Size	Zinc	4 pc.	PCL-200
<b>Pipe Clamp</b> , includes Slotted Hex Head Screw and Nut, Design Load 800 lbs.	For 2-1/2" Pipe Size	Zinc	4 pc.	PCL-250
<b>Pipe Clamp</b> , includes Slotted Hex Head Screw and Nut, Design Load 800 lbs.	For 3" Pipe Size	Zinc	4 pc.	TCL-350*
<b>Pipe Clamp</b> , includes Slotted Hex Head Screw and Nut, Design Load 1000 lbs.	For 3-1/2" Pipe Size	Zinc	4 pc.	TCL-400*
<b>Pipe Clamp</b> , includes Slotted Hex Head Screw and Nut, Design Load 1000 lbs.	For 4" Pipe Size	Zinc	4 pc.	TCL-450*
<b>Pipe Clamp</b> , includes Slotted Hex Head Screw and Nut, Design Load 1000 lbs.	For 5" Pipe Size	Zinc	4 pc.	PCL-500
<b>Pipe Clamp</b> , includes Slotted Hex Head Screw and Nut, Design Load 1000 lbs.	For 6" Pipe Size	Zinc	4 pc.	PCL-600
<b>Pipe Clamp</b> , includes Slotted Hex Head Screw and Nut, Design Load 1000 lbs.	For 8" Pipe Size	Zinc	4 pc.	PCL-800
* Tube Clamp also fits this pipe size.				
<b>Tube Clamp</b> , includes Slotted Hex Head Screw and Nut, Design Load 600 lbs.	For 1-1/2" OD Tube	Zinc	4 pc.	TCL-150
<b>Tube Clamp</b> , includes Slotted Hex Head Screw and Nut, Design Load 800 lbs.	For 2" OD Tube	Zinc	4 pc.	TCL-200
<b>Tube Clamp</b> , includes Slotted Hex Head Screw and Nut, Design Load 800 lbs.	For 2-1/8" OD Tube	Zinc	4 pc.	TCL-212
<b>Tube Clamp</b> , includes Slotted Hex Head Screw and Nut, Design Load 800 lbs.	For 2-1/4" OD Tube	Zinc	4 pc.	TCL-225
<b>Tube Clamp</b> , includes Slotted Hex Head Screw and Nut, Design Load 800 lbs.	For 2-1/2" OD Tube	Zinc	4 pc.	TCL-250
<b>Tube Clamp</b> , includes Slotted Hex Head Screw and Nut, Design Load 800 lbs.	For 3" OD Tube	Zinc	4 pc.	TCL-300
<b>Tube Clamp</b> , includes Slotted Hex Head Screw and Nut, Design Load 800 lbs.	For 3-1/2" OD Tube	Zinc	4 pc.	TCL-350
<b>Tube Clamp</b> , includes Slotted Hex Head Screw and Nut, Design Load 1000 lbs.	For 4" OD Tube	Zinc	4 pc.	TCL-400
<b>Tube Clamp</b> , includes Slotted Hex Head Screw and Nut, Design Load 1000 lbs.	For 4-1/2" OD Tube	Zinc	4 pc.	TCL-450
<b>Tube Clamp</b> , includes Slotted Hex Head Screw and Nut, Design Load 1000 lbs.	For 5" OD Tube	Zinc	4 pc.	TCL-500
<b>Tube Clamp</b> , includes Slotted Hex Head Screw and Nut, Design Load 1000 lbs.	For 6" OD Tube	Zinc	4 pc.	TCL-600
<b>Tube Clamp</b> , includes Slotted Hex Head Screw and Nut, Design Load 1000 lbs.	For 8" OD Tube	Zinc	2 pc.	TCL-800**

**TERMINOLOGY**

- CLR Center Line Radius
- ERW Electric Resistance Welded
- FNPT Female National Pipe Thread
- ID Inside Diameter
- MNPT Male National Pipe Thread
- NPS Nominal Pipe Size
- OD Outside Diameter
- SCH Schedule

Order by Product ID Number

DESCRIPTION	SIZE	MATERIAL	PKGD	PRODUCT ID
<b>Metal Sealant</b> An aluminum-colored, medium viscosity, synthetic rubber sealant with excellent adhesion to many metal, glass, wood and other surfaces.  Features: Adheres to metal, wood and glass. Seals metal to glass in windows and doors. Resists weather, water, oil and gasoline. Solids wt. approx. 46%, Flash Point (closed cup) 0° F, heavy liquid consistency, aluminum color (dry), brush or flow application. Drying time is 24 hours (1/8" dia. bead), service temp. range of -30° to 200° F. 3M Scotch-Seal™ 2084 Metal Sealant repackaged by H-P Products.	Quart Can	-	each	2084-QT

# A Few Frequently Requested Specials

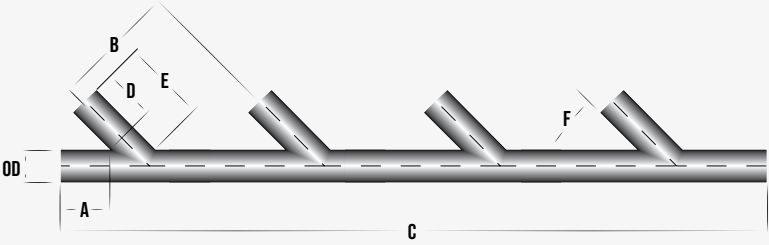

### Manifolds

OD	A	B	C	D	E	F
2.00	6.00	8.00	50.25	6.00	8.00	45.00
2.50	6.00	10.00	60.00	5.50	8.00	45.00
3.00	6.00	12.00	69.25	5.00	8.00	45.00
4.00	6.00	16.00	87.50	6.00	10.00	45.00

Typically used for multiple pick up points in vacuum conveying applications

### Flanged Stub

OD	A	B	C	D	E
1.5	6	5	3.875	0.5	0.625
2	6	6	4.75	0.5	0.75
2.5	6	7	5.5	0.5	0.75
3	6	7.5	6	0.5	0.75
3.5	6	7.5	6	0.5	0.75
4	6	9	7.5	0.5	0.75
5	6	10	8.5	0.5	0.875
6	6	11	9.5	0.5	0.875
8	6	13.5	11.75	0.5	0.875

For connecting tube to flanged connections. Use our compression coupling to connect tube ends.

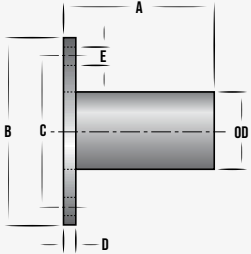

### TERMINOLOGY

- CLR Center Line Radius
- ERW Electric Resistance Welded
- FNPT Female National Pipe Thread
- ID Inside Diameter
- MNPT Male National Pipe Thread
- NPS Nominal Pipe Size
- OD Outside Diameter
- SCH Schedule

## A Few Frequently Requested Specials

### DOUBLE BOLT CLAMPS

#### WHAT WE NEED TO KNOW...

When calling for a quote please let us know the following:

- ⊗ OD (outer diameter)
- ⊗ Wall Thickness
- ⊗ Material
- ⊗ Center to Center dimension
- ⊗ Overall length

**We are here to help...Just Call!**

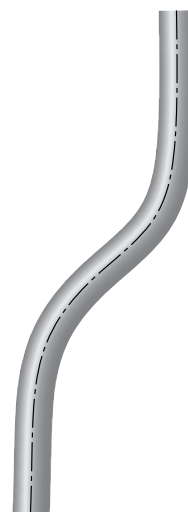

***Offset Bend***



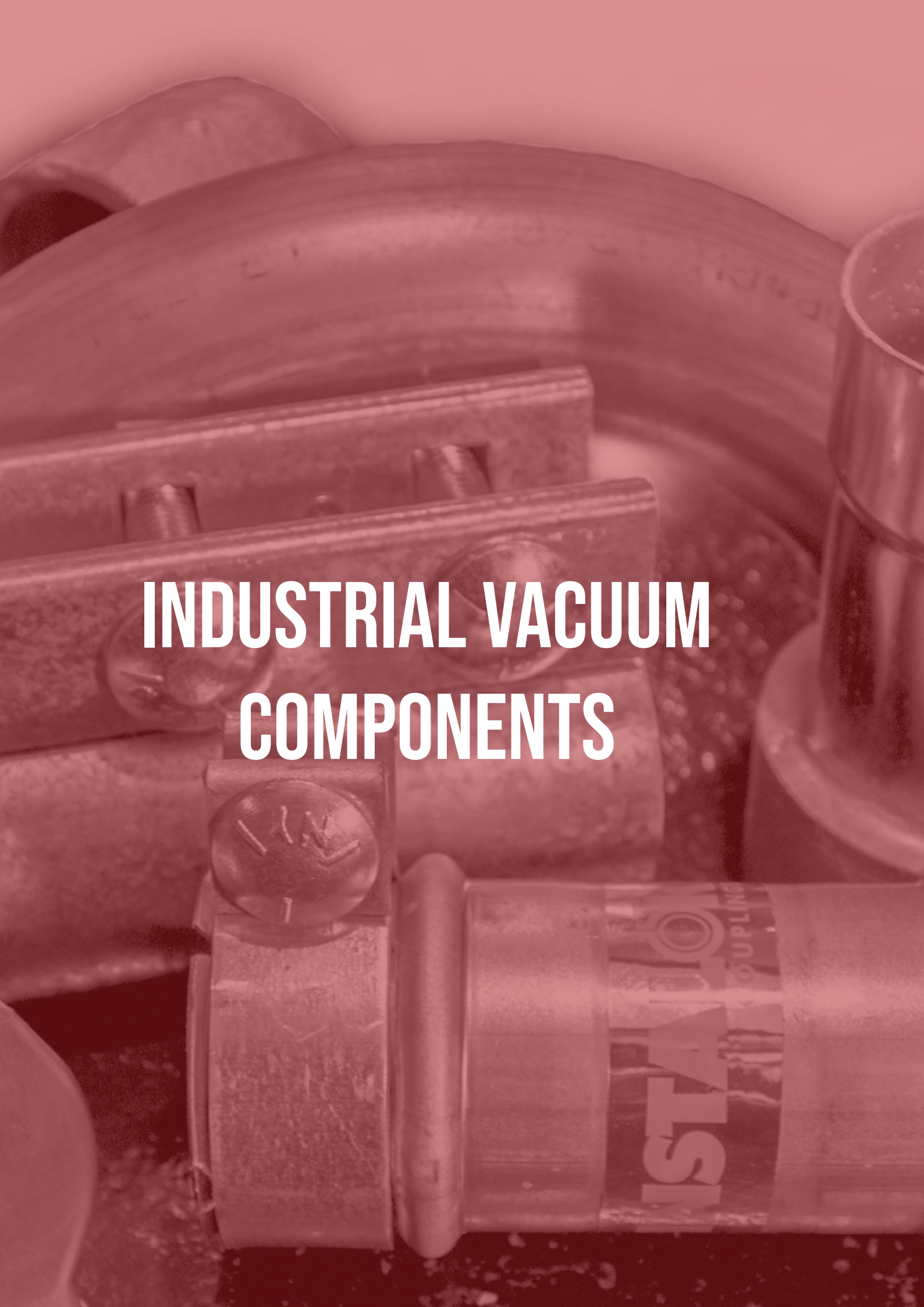

**INDUSTRIAL VACUUM  
COMPONENTS**

ISTAR  
COUPLING

# INDUSTRIAL VACUUM PRODUCTS

**H-P PRODUCTS, INC., AN ISO 9001:2015 CERTIFIED COMPANY,  
IS THE LEADING SUPPLIER OF TUBULAR COMPONENTS FOR  
INDUSTRIAL VACUUM SYSTEMS.**

## PRODUCTS

### TUBING

Our standard catalog items include tube sizes from 2-1/8" through 14" OD in Carbon, Stainless, Aluminum and Galvanized Steel. 1-1/2" and 2" OD are available upon request.

#### TUBE DIMENSIONS

**16 Gauge = .065"**  
**14 Gauge = .083"**  
**12 Gauge = .109"**  
**11 Gauge = .120"**

### CATALOG PART VARIATIONS

If our standard items don't meet your specific needs, visit our web site at [www.h-products.com](http://www.h-products.com) or contact us at 800.860.TUBE (8823) to request a quote. Custom tube fabrications are available to meet your exact specifications.

### DELIVERY

Fast delivery is available on a wide selection of in-stock Tubing, Bends, Couplings, Fittings and Installation Components.

We'll also make every effort to meet emergency requirements for non-stock items.

### PRICING

All prices are FOB factory, Louisville, Ohio  
Prices are in U.S. dollars

Prices and specifications are subject to change without notice, and without obligation. All material is invoiced at the price in effect at time of shipment. All prices and discounts are based on one shipment to one destination.

### NOTE

Specifications subject to change without notice, without incurring any obligation on our part.

### ISO 9001 CERTIFIED

H-P Products is ISO 9001:2015 Certified!

ISO-9001:2015 defines the correct and proper operation of a company in all aspects of quality, from sales to manufacturing and service. An accredited, third party assessor audited H-P Products to verify compliance with all documented procedures. H-P Products is in select company with few other central vacuum system manufacturers and fabricated air systems tubing suppliers with ISO certification.

**WHEN ORDERING,  
PLEASE SPECIFY  
TYPE OF MATERIAL**

- Carbon
- Stainless
- Aluminum
- Galvanized Steel

Catalog Part Variations Available Upon Request

**GIVE US A CALL IF YOU CAN'T FIND EXACTLY WHAT YOU NEED!**



# STANDARD ELBOWS & BENDS

All reference dimensions are nominal

## STANDARD SPECIFICATIONS

Inventories include a wide range of parts:

Standard Elbows (2-1/2" times OD)

- Short Radius Elbows (1-1/2" times OD)

- Long Radius Bends (over 2-1/2" times OD)

• Smooth, wrinkle free elbows

• Standard Gauges (2-1/8" to 4" OD = 16 Gauge)

(5" to 8" OD = 14 Gauge) (10" to 14" OD = 12 Gauge)

• 11 Gauge Available upon request with Straight Ends Only

• Materials: Carbon, Stainless, Aluminum, Galvanized Steel

## TUBE BENDING CAPABILITIES

OD (IN.)	CENTER LINE RADIUS (IN.)	GAUGE
1-1/2	1-3/4, 2-1/2, 3, 4, 6, 7-1/2, 9, 12, 15, 18, 24, 30, 36	11, 14, 16
1-3/4	2-1/2, 3, 4, 4-1/2, 6, 8, 9, 12, 15, 24, 30, 36	11, 14, 16
2	2, 2-1/2, 3, 3-1/2, 4, 5, 6, 8, 9, 10, 12, 15, 18, 24, 30, 36, 48	11, 14, 16
2-1/8	2-7/8, 3-1/2, 5, 12, 20, 24, 36	11, 14, 16
2-1/4	2-1/2, 3, 4, 5-1/2, 8, 9, 12, 15, 18, 24, 30, 36, 42	11, 14, 16
2-3/8	2-3/8, 3, 6, 8, 12, 18, 24, 30, 36, 48	16
2-1/2	2-1/2, 3, 3-1/4, 3-3/4, 4, 5, 6, 9, 12, 15, 18, 24, 30, 36, 48	11, 14, 16
2-3/4	2-3/4, 3-7/8, 15, 24, 30	11, 14, 16
2-7/8	3-3/4, 9, 10, 12, 24, 30, 36, 48, 60	11, 14, 16
3	3, 4, 4-1/2, 6, 7-1/2, 9, 12, 15, 18, 24, 30, 36, 38, 48, 60	11, 14, 16
3-1/2	3-1/2, 4, 4-1/2, 5, 6, 7-1/2, 8, 8-3/4, 12, 13, 15, 18, 24, 30, 36, 48, 60	11, 14, 15, 16
4	4, 6, 8, 9, 10, 12, 18, 24, 30, 36, 48, 60	11, 14, 16
4-1/2	6, 9, 12, 16, 20, 24, 30, 36, 48, 60	11, 14, 16
5	5, 5-1/2, 7-1/2, 12-1/2, 18, 24, 30, 36, 48, 60	11, 14, 16
6	7, 9, 15, 24, 30, 36, 48, 60	11, 14, 16
8	12, 20, 32, 48	11, 14
10	20, 32, 48	11, 12

## TUBE BENDING CAPABILITIES

NPS (INCHES)	OD (INCHES)	CENTER LINE RADIUS (INCHES)					
			5	10	40	80	OTHER
1-1/2	1.900	6, 9, 12, 18, 36	-	-	.145	.200	-
2	2.375	2-3/8, 3, 6, 8, 12, 18, 24, 30, 36, 48	.065	.109	.154	.218	-
2-1/2	2.875	3-3/4, 9, 10, 12, 24, 30, 36, 48, 60	.083	.120	.203	.276	-
3	3.500	4, 4-1/2, 5, 6, 7-1/2, 8, 8-3/4, 12, 13, 15, 18, 24, 30, 36, 48, 60	.083	.120	.216	.300	.188
3-1/2	4.000	4, 6, 8, 9, 10, 12, 18, 24, 30, 36, 48, 60	.083	.120	-	.300	-
4	4.500	6, 9, 12, 16, 20, 24, 30, 36, 48, 60	.083	.120	.237	.337	.188
5	5.563	24, 30, 36, 48, 60	-	.134	.258	.375	-
6	6.625	24	-	.134	.280	-	.188, .250
8	8.625	32	-	.148	.322	-	.188, .250

**WHEN ORDERING, PLEASE SPECIFY TYPE OF MATERIAL**

- Carbon
- Stainless
- Aluminum
- Galvanized Steel

### KEY

OD.....Outside Diameter  
NPS....Nominal Pipe Size

Catalog Part Variations Available Upon Request

**GIVE US A CALL IF YOU CAN'T FIND EXACTLY WHAT YOU NEED!**

# STANDARD TUBING

©2024 H-P Products

## STANDARD TUBING

- 2-1/8" through 14" OD
- Wall Thickness: 16, 14, 12, 11 Gauge
- Materials: Carbon, Stainless, Aluminum, Galvanized Steel

OD	GAUGE	NOMINAL WALL THICKNESS	CARBON	GALVANIZED STEEL	STAINLESS	ALUMINUM
2-1/8"	16	0.065"	16WT212C	16WT212Z	16WT212S	16ST212A
2-1/8"	11	0.120"	11WT212C	11WT212Z*	11WT212S	11ST212A
2-1/2"	16	0.065"	16WT250C	16WT250Z	16WT250S	16ST250A
2-1/2"	11	0.120"	11WT250C	11WT250Z*	11WT250S	11ST250A
3"	16	0.065"	16WT300C	16WT300Z	16WT300S	16ST300A
3"	11	0.120"	11WT300C	11WT300Z	11WT300S	11ST300A
3-1/2"	16	0.065"	16WT350C	16WT350Z	16WT350S	16ST350A
3-1/2"	11	0.120"	11WT350C	11WT350Z*	10WP300S	11ST350A
4"	16	0.065"	16WT400C	16WT400Z	16WT400S	16ST400A
4"	11	0.120"	11WT400C	11WT400Z	10WP350S	11ST400A
5"	14	0.083"	14WT500C	14WT500Z	14WT500S	14ST500A
5"	11	0.120"	11WT500C	11WT500Z	11WT500S	11ST500A
6"	14	0.083"	14WT600C	14WT600Z	14WT600S	14ST600A
6"	11	0.120"	11WT600C	11WT600Z	11WT600S	11ST600A
8"	14	0.083"	14WT800C	14WT800Z	14WT800S	14ST800A
8"	11	0.120"	11WT800C	11WT800Z	11WT800S	11ST800A
10"	12	0.109"	12WT1000C	12WT1000Z	12WT1000S	12ST1000A
12"	12	0.109"	12WT1200C	12WT1200Z	12WT1200S	12ST1200A
14"	12	0.109"	12WT1400C	12WT1400Z	**	**

Our standard stock (unless noted) is 20', but we will cut to your specifications  
 \* 10' Lengths  
 \*\* Quotation Basis

### WHEN ORDERING, PLEASE SPECIFY TYPE OF MATERIAL

- Carbon
- Stainless
- Aluminum
- Galvanized Steel

### KEY

OD.....Outside Diameter  
 GALV ..Galvanized

# STANDARD ELBOWS & BENDS

©2024 H-P Products

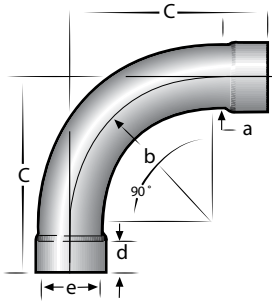

90° STANDARD RADIUS ELBOW

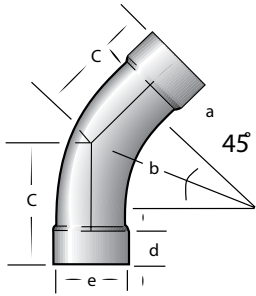

45° STANDARD RADIUS ELBOW

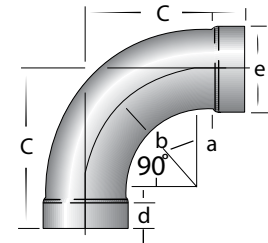

90° SHORT RADIUS ELBOW

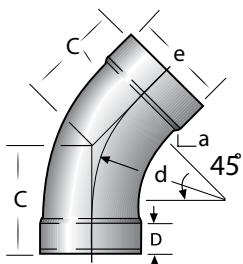

45° SHORT RADIUS ELBOW

## STANDARD RADIUS ELBOWS

- 30° AND 60° ELBOWS AVAILABLE
- 11 GAUGE ELBOWS AVAILABLE (STRAIGHT ENDS ONLY)
- EXPANDED ENDS STANDARD THROUGH 6" SIZE

- EXPANDED ONE END AVAILABLE
- STRAIGHT ENDS AVAILABLE ON ALL SIZES BY REQUEST

A (OD)	B (CLR)	GAUGE	TAN.	C	90° PART NO.	C	45° PART NO.
2"	5"	16	2"	7"	EL-202	4-1/16"	EL-201
2-1/8"	5"	16	2"	7"	EL-212	4-1/16"	EL-211
2-1/2"	6"	16	2"	8"	EL-252	4-1/2"	EL-251
3"	7-1/2"	16	2"	9-1/2"	EL-302	5-1/8"	EL-301
3-1/2"	8-3/4"	16	2"	10-3/4"	EL-352	5-5/8"	EL-351
4"	10"	16	2"	12"	EL-402	6-1/8"	EL-401
5"	12-1/2"	14	2-5/8"	15-1/8"	EL-502	7-13/16"	EL-501
6"	15"	14	3-1/4"	18-1/4"	EL-602	9-7/16"	EL-601
8"	20"	14	4-1/4"	24-1/4"	EL-802	12-9/16"	EL-801
10"	32"	12	15"	47"	EL-1002**	28-1/4"	EL-1001**
12"	36"	12	6-1/4"	42-1/4"	EL-1202**	21-5/32"	EL-1201**
14"	36"	12	7-1/4"	43-1/4"	EL-1402**	22-5/32"	EL-1401**

- Expansion depth for standard and short radius elbows 1-3/8" through 4" OD and 1-5/8" for 5" and 6" OD
- Stainless parts (10" OR LARGER OD) are segmented
- \* Stainless parts are segmented
- \*\* Segmented

## SHORT RADIUS ELBOWS

- 30° AND 60° ELBOWS AVAILABLE
- 11 GAUGE ELBOWS AVAILABLE (STRAIGHT ENDS ONLY)
- EXPANDED ENDS STANDARD THROUGH 6" SIZE

- EXPANDED ONE END AVAILABLE
- STRAIGHT ENDS AVAILABLE ON ALL SIZES BY REQUEST

A (OD)	B (CLR)	GAUGE	TAN.	C	90° PART NO.	C	45° PART NO.
2"	3"	16	2"	5"	SR-242	3-1/4"	SR-241
2-1/8"	3-1/2"	16	2"	5-1/2"	SR-212	3-7/16"	SR-211
2-1/2"	4"	16	2"	6"	SR-252	3-21/32"	SR-251
3"	4-1/2"	16	2"	6-1/2"	SR-342	3-7/8"	SR-341
3-1/2"	5"	16	2"	7"	SR-352	4-1/16"	SR-351
4"	6"	16	2"	8"	SR-442	4-1/2"	SR-441
5"	7-1/2"	14	2-5/8"	10-1/8"	SR-542	5-23/32"	SR-541
6"	9"	14	3-1/4"	12-1/4"	SR-642	6-31/32"	SR-641
8"	12"	14	4-1/4"	16-1/4"	SR-842	9-7/32"	SR-841
10"	15"	12	15"	20-1/4"	SR-1042**	13-17/32"	SR-1041**
12"	18"	12	6-1/4"	24-1/4"	SR-1242**	16-3/16"	SR-1241**

- Expansion depth for standard and short radius elbows: 1-3/8" through 4" OD and 1-5/8" for 5" and 6" OD
- \*\* Segmented

WHEN ORDERING,  
PLEASE SPECIFY  
TYPE OF MATERIAL

- Carbon
- Stainless
- Aluminum
- Galvanized Steel

### KEY

- OD = Outside Diameter
- CLR = Center Line Radius
- TAN = Tangent Length
- D = Expansion Depth 1-3/8" through 4" OD, 1-5/8" for 5" and 6" OD
- E = Inside Diameter (ID) = A Outside Diameter (OD)

# STANDARD ELBOWS & BENDS

All reference dimensions are nominal

## STANDARD LONG RADIUS BENDS

• EXPANDED ENDS AVAILABLE UPON REQUEST, EXCEPT ON 8" AND 10" BENDS & ALL 11 GAUGE BENDS

A (OD)	B (CLR)	GAUGE	C	90° PART NO.	C	45° PART NO.
2-1/8"	24"	16	30"	16-212242	15-15/16"	16-212241
2-1/8"	24"	11	30"	11-212242	15-15/16"	11-212241
2-1/8"	36"	16	42"	16-212362	20-15/16"	16-212361
2-1/8"	36"	11	42"	11-212362	20-15/16"	11-212361
2-1/2"	24"	16	30"	16-250242	15-15/16"	16-250241
2-1/2"	24"	11	30"	11-250242	15-15/16"	11-250241
2-1/2"	36"	16	42"	16-250362	20-15/16"	16-250361
2-1/2"	36"	11	42"	11-250362	20-15/16"	11-250361
3"	24"	16	30"	16-300242	15-15/16"	16-300241
3"	24"	11	30"	11-300242	15-15/16"	11-300241
3"	30"	16	36"	16-300302	18-7/16"	16-300301
3"	30"	11	36"	11-300302	18-7/16"	11-300301
3"	36"	16	42"	16-300362	20-15/16"	16-300361
3"	36"	11	42"	11-300362	20-15/16"	11-300361
3"	38"	16	44"	16-300382	21-3/4"	16-300381
3"	38"	11	44"	11-300382	21-3/4"	11-300381
3"	48"	16	54"	16-300482	25-7/8"	16-300481
3"	48"	11	54"	11-300482	25-7/8"	11-300481
3-1/2"	30"	16	37"	16-350302	19-7/16"	16-350301
3-1/2"	30"	11	37"	11-350302	19-7/16"	11-350301
3-1/2"	36"	16	43"	16-350362	21-15/16"	16-350361
3-1/2"	36"	11	43"	11-350362	21-15/16"	11-350361
3-1/2"	48"	16	55"	16-350482	26-7/8"	16-350481
3-1/2"	48"	11	55"	11-350482	26-7/8"	11-350481
4"	24"	16	32"	16-400242	17-15/16"	16-400241
4"	24"	11	32"	11-400242	17-15/16"	11-400241
4"	30"	16	38"	16-400302	20-7/16"	16-400301
4"	30"	11	38"	11-400302	20-7/16"	11-400301
4"	36"	16	44"	16-400362	22-15/16"	16-400361
4"	36"	11	44"	11-400362	22-15/16"	11-400361
4"	48"	16	56"	16-400482	27-7/8"	16-400481
4"	48"	11	56"	11-400482	27-7/8"	11-400481
4"	60"	16	68"	16-400602	32-7/8"	16-400601
4"	60"	11	68"	11-400602	32-7/8"	11-400601
5"	30"	14	40"	14-500302	22-7/16"	14-500301
5"	30"	11	40"	11-500302	22-7/16"	11-500301
5"	48"	14	58"	14-500482	29-7/8"	14-500481
5"	48"	11	58"	11-500482	29-7/8"	11-500481
6"	30"	14	42"	14-600302	24-7/16"	14-600301
6"	30"	11	42"	11-600302	24-7/16"	11-600301
6"	48"	14	60"	14-600482	31-7/8"	14-600481
6"	48"	11	60"	11-600482	31-7/8"	11-600481
6"	60"	14	72"	14-600602	36-7/8"	14-600601
6"	60"	11	72"	11-600602	36-7/8"	11-600601
8"	32"	14	48"	14-800322	29-1/4"	14-800321
8"	32"	11	48"	11-800322	29-1/4"	11-800321
8"	48"	14	64"	14-800482	31-7/8"	14-800481
8"	48"	11	64"	11-800482	31-7/8"	11-800481
10"	48"	12	70"	12-1000482*	41-7/8"	12-1000481*

• Nominal standard tangent is two times tube OD, 6" minimum  
• All standard bends have straight ends

• Nominal standard tangent for 10" bend is 22"  
• Stainless parts are segmented

### KEY

OD = Outside Diameter  
CLR = Center Line Radius  
C = Center to end  
All reference dimensions are nominal

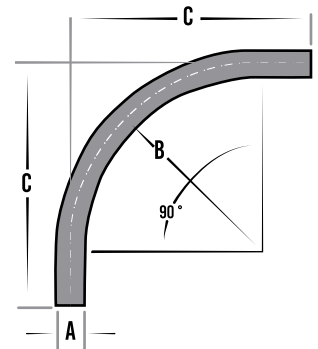

90° LONG RADIUS BEND  
(STRAIGHT END)

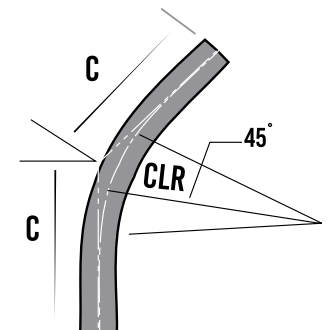

45° LONG RADIUS BEND  
STRAIGHT END

WHEN ORDERING,  
PLEASE SPECIFY  
TYPE OF MATERIAL

- Carbon
- Stainless
- Aluminum
- Galvanized Steel

Catalog Part Variations Available Upon Request

GIVE US A CALL IF YOU CAN'T FIND EXACTLY WHAT YOU NEED!

# VALVES

All reference dimensions are nominal

## INLET VALVES

Heavy duty inlet valves provide for a quick connection of the male hose coupling to the vacuum cleaning system. These parts are designed for insertion into a 2" FNPT threaded fitting adapting to a 2-1/8" tube size. Valves have self-closing covers and are available in galvanized and stainless steel, as well as nickel plated models. Escutcheon plates allow for a more attractive wall installation.

The same body is used for all three valves...only the bore varies. IV-150 and IV-200 use a slight taper for hose adapter retention. IV-200-CLIP and IV-180 utilize a clip on the valve lid for retention instead. Hose adapters are constructed of heavy-duty galvanized steel.

## INLET VALVES

BORE	MNPT	PART #
1.5"	2.0"	IV-150
1.8"	2.0"	IV-180
2.0"	2.0"	IV-200
2.0"	2.0"	IV-200-CLIP

## ESCUTCHEON PLATES

TYPE	PART #
Zinc	2.0"
Stainless	2.0"
Nickel	2.0"

## INLET VALVE ACCESSORIES FOR INSTALLATION & OPERATION

HOSE ADAPTER PART #	HOSE SIZE	INLET VALVE PART #	WRENCH PART #
HA-150	1-1/2" ID	IV-150	VW-150
HA-180	1-1/2" ID	IV-180	VW-180
HA-200	2" ID	IV-200	VW-180
HA-200-RING	2" ID	IV-200-CLIP	VW-180

## PREMIUM INLET VALVES

H-P inlet valves are also available in stainless steel or nickel plated finish

Call us for details.

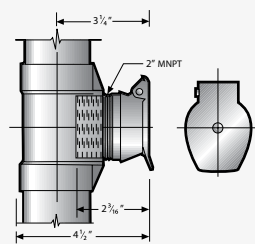

Valve shown in tube fitting (Part No. AT-212)

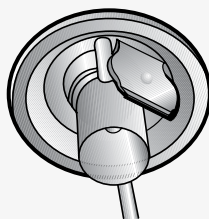

Inlet Valve with escutcheon being tightened into place with installation wrench

FNPT = Female National Pipe Thread

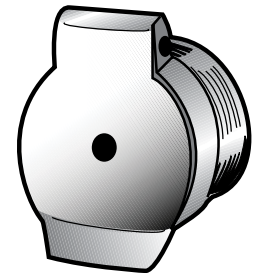

Inlet Valve with Escutcheon (For a flush mounted installation)

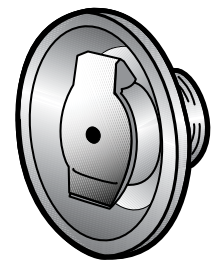

Valve shown in 90° adapter elbow (Part No. AE-211)

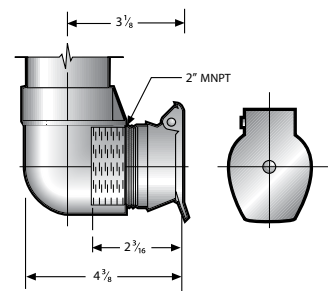

Valve shown in 90° adapter elbow (Part No. AE-211)

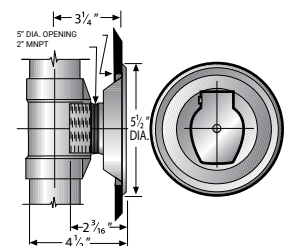

Valve with escutcheon and tee fitting. Can also be used with 90° adapter elbow

### KEY

FNPT = Female National Pipe Thread  
 MNPT = Male National Pipe Thread

Catalog Part Variations Available Upon Request

**GIVE US A CALL IF YOU CAN'T FIND EXACTLY WHAT YOU NEED!**

# FITTINGS

©2024 H-P Products

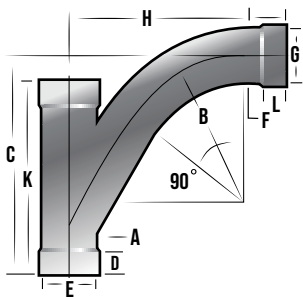
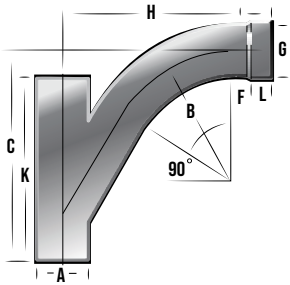

## STANDARD 90° TY'S

- 2-1/8" through 14" OD
- Wall Thickness: 16, 14, 12, (11 Gauge Available in Straight Ends Only)
- (16 Gauge: 2-1/8" to 4" OD) (14 Gauge: 5" to 8" OD) (12 Gauge: 10" to 14" OD)
- Materials: Carbon, Stainless, Aluminum, Galvanized Steel

- 11 GAUGE TY'S AVAILABLE (STRAIGHT ENDS ONLY)
- STRAIGHT AND EXPANDED COMBINATIONS AVAILABLE
- STRAIGHT ENDS AVAILABLE ON ALL SIZES BY REQUEST

SIZE	GAUGE	A (OD)	B	C	F (OD)	H	K	PART NO.
2"	16	2"	5"	9-3/32"	2"	8-5/8"	9-1/2"	TY-204
2-1/8"	16	2-1/8"	5"	9-5/32"	2-1/8"	8-13/16"	9-1/2"	TY-215
2-1/2" x 2-1/8"	16	2-1/2"	5"	9-11/32"	2-1/8"	9"	10"	TY-255
2-1/2"	16	2-1/2"	6"	10-1/2"	2-1/2"	10-1/32"	10"	TY-256
3" x 2-1/8"	16	3"	5"	9-19/32"	2-1/8"	9-1/4"	10-1/2"	TY-305
3" x 2-1/2"	16	3"	6"	10-3/4"	2-1/2"	10-9/32"	10-1/2"	TY-306
3"	16	3"	7-1/2"	12-3/8"	3"	11-25/32"	11-1/2"	TY-307
3-1/2" x 2-1/8"	16	3-1/2"	5"	9-27/32"	2-1/8"	9-1/2"	11"	TY-355
3-1/2" x 2-1/2"	16	3-1/2"	6"	11"	2-1/2"	10-17/32"	11"	TY-356
3-1/2" x 3"	16	3-1/2"	7-1/2"	12-5/8"	3"	12-1/32"	13"	TY-357
3-1/2"	16	3-1/2"	8-3/4"	14-1/8"	3-1/2"	13-11/32"	13"	TY-358
4" x 2-1/8"	16	4"	5"	10-3/32"	2-1/8"	9-3/4"	12"	TY-405
4" x 2-1/2"	16	4"	6"	11-1/4"	2-1/2"	10-25/32"	12"	TY-406
4" x 3"	16	4"	7-1/2"	12-7/8"	3"	12-9/32"	12"	TY-407
4" x 3-1/2"	16	4"	8-3/4"	14-3/8"	3-1/2"	13-19/32"	14"	TY-408
4"	16	4"	10"	15-7/8"	4"	14-19/32"	14"	TY-409
5" x 2-1/8"	14	5"	5"	10-19/32"	2-1/8"	10-1/4"	13"	TY-505
5" x 2-1/2"	14	5"	6"	11-3/4"	2-1/2"	11-9/32"	13"	TY-506
5" x 3"	14	5"	7-1/2"	13-3/8"	3"	12-25/32"	15-1/2"	TY-507
5" x 3-1/2"	14	5"	8-3/4"	14-7/8"	3-1/2"	14-3/32"	15-1/2"	TY-508
5" x 4"	14	5"	10"	16-3/8"	4"	15-13/32"	15-1/2"	TY-509
5"	14	5"	12-1/2"	19-3/8"	5"	18-5/8"	18-1/2"	TY-515
6" x 2-1/8"	14	6"	5"	11-3/32"	2-1/8"	10-3/4"	15"	TY-605
6" x 2-1/2"	14	6"	6"	12-1/4"	2-1/2"	11-25/32"	15"	TY-606
6" x 3"	14	6"	7-1/2"	13-7/8"	3"	13-9/32"	15"	TY-607
6" x 3-1/2"	14	6"	8-3/4"	15-3/8"	3-1/2"	14-19/32"	17"	TY-608
6" x 4"	14	6"	10"	16-7/8"	4"	15-29/32"	17"	TY-609
6" x 5"	14	6"	12-1/2"	19-7/8"	5"	19-1/8"	21"	TY-614
6"	14	6"	15"	22-7/8"	6"	22-11/32"	21"	TY-615
8" x 2-1/8"	14	8"	5"	12-3/32"	2-1/8"	11-3/4"	18"	TY-805
8" x 2-1/2"	14	8"	6"	13-1/4"	2-1/2"	12-25/32"	18"	TY-806
8" x 3"	14	8"	7-1/2"	14-7/8"	3"	14-9/32"	18"	TY-807
8" x 3-1/2"	14	8"	8-3/4"	16-3/8"	3-1/2"	15-19/32"	21"	TY-808
8" x 4"	14	8"	10"	17-7/8"	4"	16-29/32"	21"	TY-809
8" x 5"	14	8"	12-1/2"	20-7/8"	5"	20-1/8"	24"	TY-814
8" x 6"	14	8"	15"	23-7/8"	6"	23-11/32"	24"	TY-815
8"	14	8"	20"	29-7/8"	8"	29-17/32"	29"	TY-816
10" x 2-1/8"	12	10"	5"	13-3/32"	2-1/8"	12-3/4"	21"	TY-1005

• EXPANDED ENDS STANDARD THROUGH 6" SIZE  
\* SEGMENTED

**WHEN ORDERING,  
PLEASE SPECIFY  
TYPE OF MATERIAL**

- Carbon
- Stainless
- Aluminum
- Galvanized Steel

### KEY

OD = Outside Diameter  
 D = Expansion Depth 1-3/8" through 4" OD, 1-5/8" for 5" and 6" OD  
 A = Outside Diameter (OD) = E Inside Diameter (ID)  
 F = Outside Diameter (OD) = G Inside Diameter (ID)  
 L = Expansion Depth 1-3/8" through 4" OD, 1-5/8" for 5" and 6" OD  
 All reference dimensions are nominal.

# FITTINGS

All reference dimensions are nominal

## STANDARD 90° TY'S -CONT.

- 11 GAUGE TY'S AVAILABLE (STRAIGHT ENDS ONLY)
- STRAIGHT AND EXPANDED COMBINATIONS AVAILABLE
- STRAIGHT ENDS AVAILABLE ON ALL SIZES BY REQUEST

SIZE	GAUGE	A (OD)	B	C	F (OD)	H	K	PART NO.
10" x 2-1/2"	12	10"	6"	14-1/4"	2-1/2"	13-25/32"	21"	TY-1006
10" x 3"	12	10"	7-1/2"	15-7/8"	3"	15-9/32"	21"	TY-1007
10" x 3-1/2"	12	10"	8-3/4"	17-3/8"	3-1/2"	16-17/32"	24"	TY-1008
10" x 4"	12	10"	10"	18-7/8"	4"	17-29/32"	24"	TY-1009
10" x 5"	12	10"	12-1/2"	21-7/8"	5"	21-1/8"	24"	TY-1014
10" x 6"	12	10"	15"	24-7/8"	6"	24-11/32"	28"	TY-1015
10" x 8"	12	10"	20"	30-7/8"	8"	30-17/32"	32"	TY-1016
10"	12	10"	32"*	40-3/8"	10"	42-25/32"	36"	TY-1017
12" x 2-1/8"	12	12"	5"	14-3/32"	2-1/8"	13-3/4"	24"	TY-1205
12" x 2-1/2"	12	12"	6"	15-1/4"	2-1/2"	14-25/32"	24"	TY-1206
12" x 3"	12	12"	7-1/2"	16-7/8"	3"	16-9/32"	24"	TY-1207
12" x 3-1/2"	12	12"	8-3/4"	18-3/8"	3-1/2"	17-19/32"	27"	TY-1208
12" x 4"	12	12"	10"	19-7/8"	4"	18-29/32"	27"	TY-1209
12" x 5"	12	12"	12-1/2"	22-7/8"	5"	22-1/8"	27"	TY-1214
12" x 6"	12	12"	15"	25-7/8"	6"	25-11/32"	31"	TY-1215
12" x 8"	12	12"	20"	31-7/8"	8"	31-17/32"	35"	TY-1216
12" x 10"	12	12"	32" *	41-3/8"	10"	43-25/32"	39"	TY-1217
12"	12	12"	36"*	46-7/8"	12"	49-1/8"	43"	TY-1218
14" x 8"	12	14"	20"	32-7/8"	8"	32-17/32"	38"	TY-1416
14" x 10"	12	14"	32" *	42-3/8"	10"	44-25/32"	42"	TY-1417
14" x 12"	12	14"	36"*	47-7/8"	12"	50-1/8"	46"	TY-1418
14"	12	14"	36"*	51-3/8"	14"	50-3/4"	52"	TY-1419

• EXPANDED ENDS STANDARD THROUGH 6" SIZE  
\* SEGMENTED

### KEY

OD = Outside Diameter  
F = Outside Diameter (OD) = G = Inside Diameter (ID)  
L = Expansion Depth 1-3/8" through 4" OD, 1-5/8" for 5" and 6" OD  
All reference dimensions are nominal.

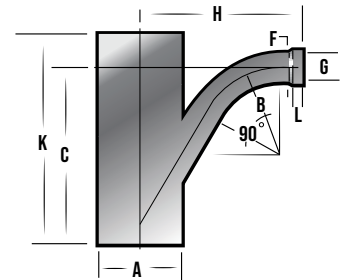

90° TY  
(ONE END EXPANDED)

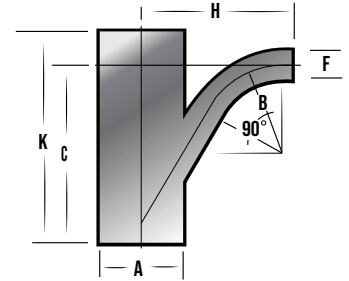

90° TY  
(STRAIGHT ENDS)

WHEN ORDERING,  
PLEASE SPECIFY  
TYPE OF MATERIAL

- Carbon
- Stainless
- Aluminum
- Galvanized Steel

Catalog Part Variations Available Upon Request

GIVE US A CALL IF YOU CAN'T FIND EXACTLY WHAT YOU NEED!

# FITTINGS

©2024 H-P Products

## STANDARD 45° YL'S

- 2-1/8" through 14" OD
- Wall Thickness: 16, 14, 12, (11 Gauge Available in Straight Ends Only)
- (16 Gauge: 2-1/8" to 4" OD) (14 Gauge: 5" to 8" OD) (12 Gauge: 10" to 14" OD)
- Materials: Carbon, Stainless, Aluminum, Galvanized Steel

- 11 GAUGE TY'S AVAILABLE (STRAIGHT ENDS ONLY)
- STRAIGHT AND EXPANDED COMBINATIONS AVAILABLE
- STRAIGHT ENDS AVAILABLE ON ALL SIZES BY REQUEST

SIZE	GAUGE	A (OD)	B	C	F (OD)	H	K	PART NO.
2"	16	2"	5"	9-1/16"	2"	4-9/16"	9-1/2"	YL-2041
2-1/8"	16	2-1/8"	5"	9-3/32"	2-1/8"	4-11/16"	9-1/2"	YL-2151
2-1/2" x 2-1/8"	16	2-1/2"	5"	9-9/32"	2-1/8"	4-7/8"	10"	YL-2551
2-1/2"	16	2-1/2"	6"	10-5/32"	2-1/2"	5-3/16"	10"	YL-2561
3" x 2-1/8"	16	3"	5"	9-17/32"	2-1/8"	5-1/8"	10-1/2"	YL-3051
3" x 2-1/2"	16	3"	6"	10-13/32"	2-1/2"	5-7/16"	10-1/2"	YL-3061
3"	16	3"	7-1/2"	11-19/32"	3"	5-29/32"	11-1/2"	YL-3071
3-1/2" x 2-1/8"	16	3-1/2"	5"	9-25/32"	2-1/8"	5-3/8"	11"	YL-3551
3-1/2" x 2-1/2"	16	3-1/2"	6"	10-21/32"	2-1/2"	5-11/16"	11"	YL-3561
3-1/2" x 3"	16	3-1/2"	7-1/2"	11-27/32"	3"	6-5/32"	13"	YL-3571
3-1/2"	16	3-1/2"	8-3/4"	12-31/32"	3-1/2"	6-9/16"	13"	YL-3581
4" x 2-1/8"	16	4"	5"	10-1/32"	2-1/8"	5-5/8"	12"	YL-4051
4" x 2-1/2"	16	4"	6"	10-29/32"	2-1/2"	5-15/16"	12"	YL-4061
4" x 3"	16	4"	7-1/2"	12-3/32"	3"	6-13/32"	12"	YL-4071
4" x 3-1/2"	16	4"	8-3/4"	13-7/32"	3-1/2"	6-13/16"	14"	YL-4081
4"	16	4"	10"	14-11/32"	4"	7-1/4"	14"	YL-4091
5" x 2-1/8"	14	5"	5"	10-17/32"	2-1/8"	6-1/8"	13"	YL-5051
5" x 2-1/2"	14	5"	6"	11-13/32"	2-1/2"	6-7/16"	13"	YL-5061
5" x 3"	14	5"	7-1/2"	12-19/32"	3"	6-29/32"	15-1/2"	YL-5071
5" x 3-1/2"	14	5"	8-3/4"	13-23/32"	3-1/2"	7-5/16"	15-1/2"	YL-5081
5" x 4"	14	5"	10"	14-27/32"	4"	7-3/4"	15-1/2"	YL-5091
5"	14	5"	12-1/2"	17-9/16"	5"	9"	18-1/2"	YL-5151
6" x 2-1/8"	14	6"	5"	11-1/32"	2-1/8"	6-5/8"	15"	YL-6051
6" x 2-1/2"	14	6"	6"	11-29/32"	2-1/2"	6-15/16"	15"	YL-6061
6" x 3"	14	6"	7-1/2"	13-3/32"	3"	7-13/32"	15"	YL-6071
6" x 3-1/2"	14	6"	8-3/4"	14-7/32"	3-1/2"	7-13/16"	17"	YL-6081
6" x 4"	14	6"	10"	15-11/32"	4"	8-1/4"	17"	YL-6091
6" x 5"	14	6"	12-1/2"	18-1/16"	5"	9-1/2"	21"	YL-6141
6"	14	6"	15"	20-25/32"	6"	10-25/32"	21"	YL-6151
8" x 2-1/8"	14	8"	5"	12-1/32"	2-1/8"	7-5/8"	18"	YL-8051
8" x 2-1/2"	14	8"	6"	12-29/32"	2-1/2"	7-15/16"	18"	YL-8061
8" x 3"	14	8"	7-1/2"	14-3/32"	3"	8-13/32"	18"	YL-8071
8" x 3-1/2"	14	8"	8-3/4"	15-7/32"	3-1/2"	8-13/16"	21"	YL-8081
8" x 4"	14	8"	10"	16-11/32"	4"	9-1/4"	21"	YL-8091
8" x 5"	14	8"	12-1/2"	19-1/16"	5"	10-1/2"	24"	YL-8141
8" x 6"	14	8"	15"	21-25/32"	6"	11-25/32"	24"	YL-8151
8"	14	8"	20"	27"	8"	14-5/32"	29"	YL-8161
10" x 2-1/8"	12	10"	5"	13-1/32"	2-1/8"	8-5/8"	21"	YL-10051

\* EXPANDED ENDS STANDARD THROUGH 6" SIZE  
\* SEGMENTED

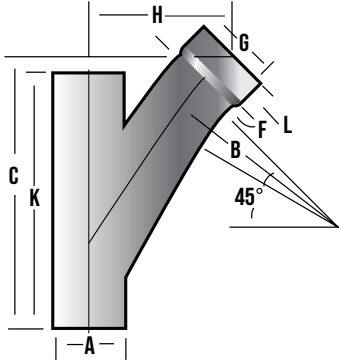

45° YL  
(ONE END EXPANDED)

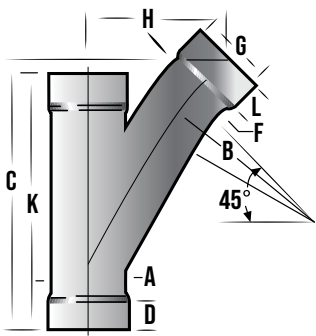

45° YL  
(THREE ENDS EXPANDED)

WHEN ORDERING,  
PLEASE SPECIFY  
TYPE OF MATERIAL

- Carbon
- Stainless
- Aluminum
- Galvanized Steel

### KEY

OD = Outside Diameter  
D = Expansion Depth 1-3/8" through 4" OD, 1-5/8" for 5" and 6" OD  
A = Outside Diameter (OD) = E Inside Diameter (ID)  
F = Outside Diameter (OD) = G Inside Diameter (ID)  
L = Expansion Depth 1-3/8" through 4" OD, 1-5/8" for 5" and 6" OD  
All reference dimensions are nominal.



# FITTINGS

All reference dimensions are nominal

## STANDARD 45° YL'S - CONT.

- 11 GAUGE TY'S AVAILABLE (STRAIGHT ENDS ONLY)
- STRAIGHT AND EXPANDED COMBINATIONS AVAILABLE
- STRAIGHT ENDS AVAILABLE ON ALL SIZES BY REQUEST

SIZE	GAUGE	A (OD)	B	C	F (OD)	H	K	PART NO.
10" X 2-1/2"	12	10"	6"	13-29/32"	2-1/2"	8-15/16"	21"	YL-10061
10" X 3"	12	10"	7-1/2"	15-3/32"	3"	9-13/32"	21"	YL-10071
10" X 3-1/2"	12	10"	8-3/4"	16-7/32"	3-1/2"	9-13/16"	24"	YL-10081
10" X 4"	12	10"	10"	17-11/32"	4"	10-1/4"	24"	YL-10091
10" X 5"	12	10"	12-1/2"	20-1/16"	5"	11-1/2"	24"	YL-10141
10" X 6"	12	10"	15"	22-3/4"	6"	12-25/32"	28"	YL-10151
10" X 8"	12	10"	20"	28"	8"	15-5/32"	32"	YL-10161
10"	12	10"	32"*	34-11/16"	10"	18-5/8"	36"	YL-10171
12" X 2-1/8"	12	12"	5"	14-1/32"	2-1/8"	9-5/8"	24"	YL-12051
12" X 2-1/2"	12	12"	6"	14-29/32"	2-1/2"	9-31/32"	24"	YL-12061
12" X 3"	12	12"	7-1/2"	16-3/32"	3"	10-13/32"	24"	YL-12071
12" X 3-1/2"	12	12"	8-3/4"	17-7/32"	3-1/2"	10-13/16"	27"	YL-12081
12" X 4"	12	12"	10"	18-11/32"	4"	11-1/4"	27"	YL-12091
12" X 5"	12	12"	12-1/2"	21-1/16"	5"	12-1/2"	27"	YL-12141
12" X 6"	12	12"	15"	23-3/4"	6"	13-25/32"	31"	YL-12151
12" X 8"	12	12"	20"	29"	8"	16-5/32"	35"	YL-12161
12" X 10"	12	12"	32" *	35-11/16"	10"	19-5/8"	39"	YL-12171
12"	12	12"	36"*	40-3/4"	12"	21-27/32"	43"	YL-12181
14" X 8"	12	14"	20"	30"	8"	17-5/32"	38"	YL-14161
14" X 10"	12	14"	32" *	36-11/32"	10"	20-5/8"	42"	YL-14171
14" X 12"	12	14"	36"*	41-3/4"	12"	22-27/32"	46"	YL-14181
14"	12	14"	36"*	45-15/16"	14"	24-13/32"	52"	YL-14191

• EXPANDED ENDS STANDARD THROUGH 6" SIZE  
\* SEGMENTED

### KEY

OD = Outside Diameter  
F = Outside Diameter (OD) = G = Inside Diameter (ID)  
L = Expansion Depth 1-3/8" through 4" OD, 1-5/8" for 5" and 6" OD  
All reference dimensions are nominal.

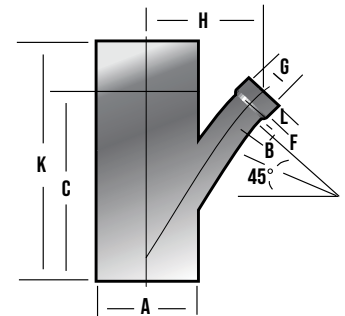

45° YL  
(ONE END EXPANDED)

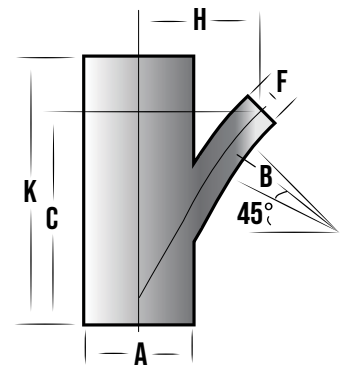

45° YL  
(THREE ENDS EXPANDED)

WHEN ORDERING,  
PLEASE SPECIFY  
TYPE OF MATERIAL

- Carbon
- Stainless
- Aluminum
- Galvanized Steel

Catalog Part Variations Available Upon Request

GIVE US A CALL IF YOU CAN'T FIND EXACTLY WHAT YOU NEED!

# FITTINGS

©2024 H-P Products

## STANDARD DOUBLE Y'S

- 2-1/8" through 6" OD
- Wall Thickness: 16, 14, (11 Gauge Available in Straight Ends Only)
- (16 Gauge: 2-1/8" to 4" OD) (14 Gauge: 5" to 6" OD)
- Materials: Carbon, Stainless, Aluminum, Galvanized Steel

## STANDARD DOUBLE 90° TY'S

- 11 GAUGE TY'S AVAILABLE (STRAIGHT ENDS ONLY)
- STRAIGHT AND EXPANDED COMBINATIONS AVAILABLE
- STRAIGHT ENDS AVAILABLE ON ALL SIZES BY REQUEST

SIZE	GAUGE	A (OD)	B	C	F (OD)	H	K	PART NO.
2-1/8"	16	2-1/8"	5"	9-5/32"	2-1/8"	8-13/16"	9-1/2"	DTY-215
2-1/2"	16	2-1/2"	6"	10-1/2"	2-1/2"	10-1/32"	10"	DTY-256
3"	16	3"	7-1/2"	12-3/8"	3"	11-25/32"	11-1/2"	DTY-307
3-1/2"	16	3-1/2"	8-3/4"	14-1/8"	3-1/2"	13-11/32"	13"	DTY-358
4"	16	4"	10"	15-7/8"	4"	14-29/32"	14"	DTY-409
5"	14	5"	12-1/2"	19-3/8"	5"	18-5/8"	18-1/2"	DTY-515
6"	14	6"	15"	22-7/8"	6"	22-11/32"	21"	DTY-615

• EXPANDED ENDS STANDARD

## STANDARD DOUBLE 45° YL'S

- 11 GAUGE YL'S AVAILABLE (STRAIGHT ENDS ONLY)
- STRAIGHT AND EXPANDED COMBINATIONS AVAILABLE
- STRAIGHT ENDS AVAILABLE ON ALL SIZES BY REQUEST

SIZE	GAUGE	A (OD)	B	C	F (OD)	H	K	PART NO.
2-1/8"	16	2-1/8"	5"	9-5/32"	2-1/8"	4-11/16"	9-1/2"	DYL-2151
2-1/2"	16	2-1/2"	6"	10-5/32"	2-1/2"	5-3/16"	10"	DYL-2561
3"	16	3"	7-1/2"	11-19/32"	3"	5-29/32"	11-1/2"	DYL-3071
3-1/2"	16	3-1/2"	8-3/4"	12-31/32"	3-1/2"	6-9/16"	13"	DYL-3581
4"	16	4"	10"	14-11/32"	4"	7-1/4"	14"	DYL-4091
5"	14	5"	12-1/2"	17-9/16"	5"	9"	18-1/2"	DYL-5151
6"	14	6"	15"	20-25/32"	6"	10-15/32"	21"	DYL-6151

• EXPANDED ENDS STANDARD

## STANDARD DOUBLE 90° Y'S

- 11 GAUGE Y'S AVAILABLE (STRAIGHT ENDS ONLY)
- STRAIGHT AND EXPANDED COMBINATIONS AVAILABLE
- STRAIGHT ENDS AVAILABLE ON ALL SIZES BY REQUEST

SIZE	GAUGE	A (OD)	B	C	F (OD)	H	K	PART NO.
2-1/8"	16	2-1/8"	5"	7"	2-1/8"	7"	-	DY-215
2-1/2"	16	2-1/2"	6"	8"	2-1/2"	8"	-	DY-256
3"	16	3"	7-1/2"	9-1/2"	3"	9-1/2"	-	DY-307
3-1/2"	16	3-1/2"	8-3/4"	10-3/4"	3-1/2"	10-3/4"	-	DY-358
4"	16	4"	10"	12"	4"	12"	-	DY-409
5"	14	5"	12-1/2"	15-1/8"	5"	15-1/8"	-	DY-515
6"	14	6"	15"	18-1/4"	6"	18-1/4"	-	DY-615

• EXPANDED ENDS STANDARD

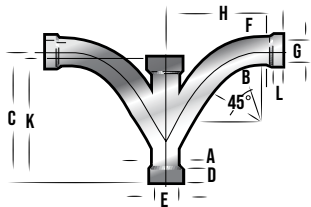

STANDARD DOUBLE 90° TY

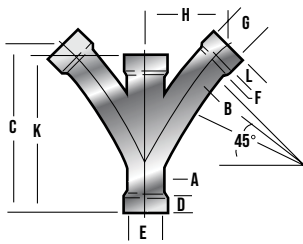

STANDARD DOUBLE 45° YL

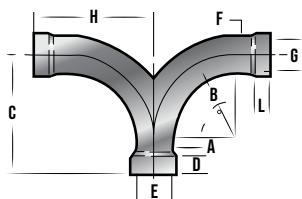

STANDARD DOUBLE 90° Y

WHEN ORDERING,  
PLEASE SPECIFY  
TYPE OF MATERIAL

- Carbon
- Stainless
- Aluminum
- Galvanized Steel

### KEY

OD = Outside Diameter  
 D = Expansion Depth 1-3/8" through 4" OD, 1-5/8" for 5" and 6" OD  
 A = Outside Diameter (OD) = E Inside Diameter (ID)  
 F = Outside Diameter (OD) = G Inside Diameter (ID)  
 L = Expansion Depth 1-3/8" through 4" OD, 1-5/8" for 5" and 6" OD  
 All reference dimensions are nominal.

# FITTINGS

All reference dimensions are nominal

## STANDARD REDUCING COUPLINGS

- 2-1/8" through 14" OD
- Wall Thickness: 16, 14, 12, (11 Gauge Available in Straight Ends Only)
- Materials: Carbon, Stainless, Aluminum, Galvanized Steel
- 11 GAUGE AVAILABLE (STRAIGHT ENDS ONLY)
- STRAIGHT ENDS AVAILABLE ON ALL SIZES BY REQUEST

SIZE	GAUGE	A (OD)	C	D	E (ID)	F (OD)	G	K	PART NO.
2-1/8" x 2"	16	2-1/8"	4"	1-25/32"	2" ID	-	1-1/8"	2"	RC-212
2-1/2" x 2-1/8"	16	2-1/2"	4-1/2"	1-3/4"	2-1/8" ID	-	1-3/8"	1-1/2"	RC-254
3" x 2-1/8"	16	3"	8-3/4"	2-1/4"	2-1/8" ID	-	1-3/8"	2"	RC-3041
3" x 2-1/2"	16	3"	5"	2"	2-1/2" ID	-	1-3/8"	1-1/2"	RC-304
3-1/2" X 2-1/8"	16	3-1/2"	11"	2-1/4"	2-1/8" ID	-	1-3/8"	2"	RC-3541
3-1/2" X 2-1/2"	16	3-1/2"	9-1/4"	2-7/8"	2-1/2" ID	-	1-3/8"	2-7/8"	RC-3542
3-1/2" X 3"	16	3-1/2"	5-1/2"	2-1/8"	3" ID	-	1-3/8"	2-1/8"	RC-354
4" X 2-1/8"	16	4"	13-1/2"	1-5/8"	2-1/8" ID	-	1-3/8"	2"	RC-4041
4" X 2-1/2"	16	4"	10-1/2"	2-1/4"	2-1/2" ID	-	1-3/8"	2"	RC-4042
4" X 3"	16	4"	9-1/4"	2-1/4"	3" ID	-	1-3/8"	2"	RC-4043
4" X 3-1/2"	16	4"	6"	2"	3-1/2" ID	-	1-3/8"	1-1/2"	RC-404
5" X 2-1/8"	14	5"	19-1/4"	2-1/4"	2-1/8" ID	-	1-3/8"	2-3/4"	RC-5041
5" X 2-1/2"	14	5"	17-1/2"	2-1/4"	2-1/2" ID	-	1-3/8"	2-3/4"	RC-5042
5" X 3"	14	5"	15"	2-1/4"	3" ID	-	1-3/8"	2-3/4"	RC-5043
5" X 3-1/2"	14	5"	12-1/2"	2-1/4"	3-1/2" ID	-	1-3/8"	2-3/4"	RC-5044
5" X 4"	14	5"	8"	2-1/4"	4" ID	-	1-3/8"	1-3/4"	RC-504
6" X 2-1/8"	14	6"	24-3/4"	2-1/4"	2-1/8" ID	-	1-3/8"	3-1/4"	RC-6041
6" X 2-1/2"	14	6"	23"	2-1/4"	2-1/2" ID	-	1-3/8"	3-1/4"	RC-6042
6" X 3"	14	6"	20-1/2"	2-1/4"	3" ID	-	1-3/8"	3-1/4"	RC-6043
6" X 3-1/2"	14	6"	18"	2-1/4"	3-1/2" ID	-	1-3/8"	3-1/4"	RC-6044
6" X 4"	14	6"	15-3/4"	2-1/4"	4" ID	-	1-3/8"	3-1/4"	RC-6045
6" X 5"	14	6"	10"	2-5/8"	5" ID	-	1-3/8"	1-3/4"	RC-604
8" X 4"	14	8"	26-1/4"	2"	4" ID	-	1-3/8"	4-1/4"	RC-8044
8" X 5"	14	8"	21-7/8"	2-5/8"	5" ID	-	1-5/8"	4-1/4"	RC-8045
8" X 6"	14	8"	16-1/2"	3-1/4"	6" ID	-	1-5/8"	3-5/8"	RC-804
10" X 6"	12	10"	28-1/2"	3-1/4"	6" ID	-	1-5/8"	5-1/4"	RC-10046
10" X 8"	12	10"	18-1/4"	2-1/2"	-	8" OD	N/A	5-1/4"	RC-1004
12" X 8"	12	12"	29-1/4"	2-1/2"	-	8" OD	N/A	6-1/4"	RC-12048
12" X 10"	12	12"	19-3/4"	3-1/4"	-	10" OD	N/A	6"	RC-1204
14" X 10"	12	14"	30"	3"	-	10" OD	N/A	7-1/4"	RC-1404
14" X 12"	12	14"	20"	4"	-	12" OD	N/A	7-1/4"	RC-1405

• EXPANDED ENDS STANDARD THROUGH 6" SIZE (ON SMALL END OF REDUCER)

### KEY

OD = Outside Diameter  
 ID = Inside Diameter  
 All reference dimensions are nominal.  
 G = Expansion Depth

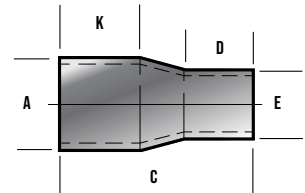

STANDARD REDUCING COUPLING  
(STRAIGHT END)

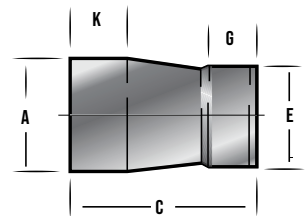

STANDARD REDUCING COUPLING  
(EXPANDED END)

### Other sizes available

Please call a Customer Service Representative for information.

### WHEN ORDERING, PLEASE SPECIFY TYPE OF MATERIAL

- Carbon
- Stainless
- Aluminum
- Galvanized Steel

Catalog Part Variations Available Upon Request

**GIVE US A CALL IF YOU CAN'T FIND EXACTLY WHAT YOU NEED!**

# FITTINGS

©2024 H-P Products

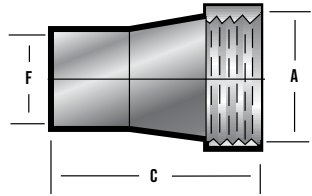

**FEMALE ADAPTER**

## KEY

FNPT = Female National Pipe Thread  
 OD = Outside Diameter  
 MNPT = Male National Pipe Thread  
 ID = Inside Diameter  
 All reference dimensions are nominal.

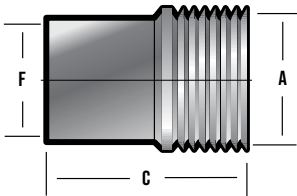

**MALE ADAPTER**

## WHEN ORDERING, PLEASE SPECIFY TYPE OF MATERIAL

- Carbon
- Stainless
- Aluminum
- Galvanized Steel

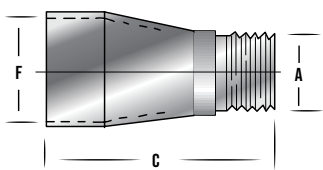

**MALE ADAPTER**

## STANDARD ADAPTERS

- 2" to 12"
- Wall Thickness: 16, 14, 12, 11 Gauge
- Materials: Carbon, Stainless, Aluminum, Galvanized Steel

## FEMALE ADAPTERS - STRAIGHT

• 11 GAUGE AVAILABLE

SIZE	GAUGE	A-FNPT	C	F (OD)	PART NO.
2" to 2"	16	2"	6"	2"	FA-201
2" to 2-1/8"	16	2"	6"	2-1/8"	FA-211
2-1/2" to 2-1/2"	16	2-1/2"	6"	2-1/2"	FA-251
3" to 3"	16	3"	6"	3"	FA-301
3-1/2" to 3-1/2"	16	3-1/2"	6"	3-1/2"	FA-351
4" to 4"	16	4"	6-1/2"	4"	FA-401
5" to 5"	14	5"	6-3/4"	5"	FA-501
6" to 6"	14	6"	7"	6"	FA-601
8" to 8"	14	8"	9"	8"	FA-801
10" to 10"	12	10"	11"	10"	FA-1001
12" to 12"	12	12"	13"	12"	FA-1201

## MALE ADAPTERS - STRAIGHT

• 11 GAUGE AVAILABLE

SIZE	GAUGE	A-FNPT	C	F (OD)	PART NO.
2" to 2"	16	2"	6"	2"	MA-202
2" to 2-1/8"	16	2"	6"	2-1/8"	MA-212
2-1/2" to 2-1/2"	16	2-1/2"	6"	2-1/2"	MA-252
3" to 3"	16	3"	6"	3"	MA-302
3-1/2" to 3-1/2"	16	3-1/2"	6"	3-1/2"	MA-352
4" to 4"	16	4"	6"	4"	MA-402
5" to 5"	14	5"	6-1/2"	5"	MA-502
6" to 6"	14	6"	7"	6"	MA-602
8" to 8"	14	8"	8"	8"	MA-802
10" to 10"	12	10"	8-1/2"	10"	MA-1002
12" to 12"	12	12"	9"	12"	MA-1202

## MALE ADAPTERS - STRAIGHT

- 2-1/8"
- Materials: Carbon, Stainless, Aluminum, Galvanized Steel

SIZE	A-MNPT	C	D	F (ID)	F (OD)	PART NO.
2-1/8" x 1-1/4"	1-1/4"	5-3/4"	-	-	2-1/8"	MA-16
2-1/8" x 1-1/2"	1-1/2"	5-3/4"	-	-	2-1/8"	MA-17
2-1/8" x 1-1/4"	1-1/4"	5-3/4"	1-1/4"*	2-1/8"	-	MA-18
2-1/8" x 1-1/2"	1-1/2"	5-3/4"	1-1/4"*	2-1/8"	-	MA-19

\* EXPANSION DEPTH

# FITTINGS

All reference dimensions are nominal

## STANDARD ADAPTERS - CONT.

### FEMALE AND MALE ADAPTERS - EXPANDED

- 2" to 6"
- Wall Thickness: 16, 14, 12 Gauge
- Materials: Carbon, Stainless, Aluminum, Galvanized Steel

SIZE	GAUGE	A-FNPT	C	D	E (ID)	PART NO.
2" to 2"	16	2"	6"	1-1/8"	2"	FA-203
2" to 2-1/8"	16	2"	6"	1-3/8"	2-1/8"	FA-213
2-1/2" to 2-1/2"	16	2-1/2"	6"	1-3/8"	2-1/2"	FA-253
3" to 3"	16	3"	6"	1-3/8"	3"	FA-303
3-1/2" to 3-1/2"	16	3-1/2"	6"	1-3/8"	3-1/2"	FA-353
4" to 4"	16	4"	6-1/2"	1-3/8"	4"	FA-403
5" to 5"	14	5"	6-3/4"	1-5/8"	5"	FA-503
6" to 6"	14	6"	7"	1-5/8"	6"	FA-603

### MALE ADAPTERS - EXPANDED

SIZE	GAUGE	A-FNPT	C	D	E (ID)	PART NO.
2" to 2"	16	2"	6"	1-1/8"	2"	MA-204
2" to 2-1/8"	16	2"	6"	1-3/8"	2-1/8"	MA-214
2-1/2" to 2-1/2"	16	2-1/2"	6"	1-3/8"	2-1/2"	MA-254
3" to 3"	16	3"	6"	1-3/8"	3"	MA-304
3-1/2" to 3-1/2"	16	3-1/2"	6"	1-3/8"	3-1/2"	MA-354
4" to 4"	16	4"	6-1/2"	1-3/8"	4"	MA-404
5" to 5"	14	5"	6-3/4"	1-5/8"	5"	MA-504
6" to 6"	14	6"	7"	1-5/8"	6"	MA-604

### 90° ADAPTER ELBOW

- 2-1/8" to 2"
- Available only in Cast Gray Iron, Zinc, Nickel Plated or Cast Aluminum

SIZE	C	D	E (ID)	H	L-FNPT	PART NO.
2-1/8" to 2"	2-9/16"	1-3/8"	2-1/8"	1-5/8"	2"	AE-211*

\* AVAILABLE ONLY IN CAST GRAY IRON, ZINC, NICKEL PLATED OR CAST ALUMINUM

### 90° ADAPTER TEE

- 2-1/8" to 2"
- Available only in Cast Gray Iron, Zinc, Nickel Plated or Cast Aluminum

SIZE	C	D	E (ID)	H	L-FNPT	PART NO.
2-1/8" to 2"	4-13/16"	1-3/8"	2-1/8"	1-9/16"	2"	AT-212*
2-1/2" to 2"	6-1/2"	1-3/8"	2-1/2"	2-1/8"	2"	AT-250
3" to 2"	6-1/2"	1-3/8"	3"	2-3/4"	2"	AT-302
3-1/2" to 2"	6-7/8"	1-3/8"	3-1/2"	3-7/16"	2"	AT-352
4" to 2"	6-7/8"	1-3/8"	4"	3-7/16"	2"	AT-402

\* AVAILABLE ONLY IN CAST GRAY IRON, ZINC, NICKEL PLATED OR CAST ALUMINUM & NOT 11 GAUGE

### WHEN ORDERING, PLEASE SPECIFY TYPE OF MATERIAL

- Carbon
- Stainless
- Aluminum
- Galvanized Steel

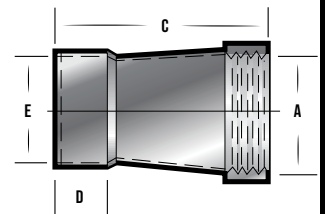

FEMALE ADAPTER

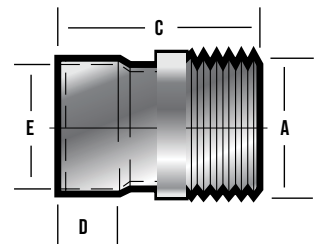

MALE ADAPTER EXPANDED

### KEY

FNPT = Female National Pipe Thread  
ID = Inside Diameter  
MNPT = Male National Pipe Thread  
All reference dimensions are nominal.

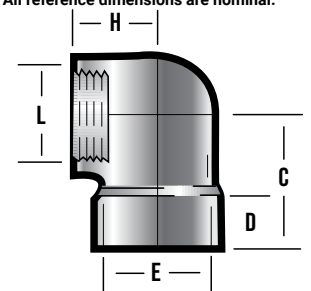

90° ADAPTER ELBOW

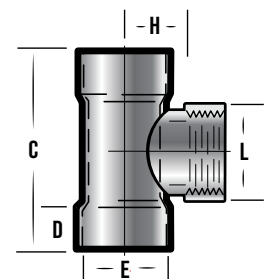

ADAPTER TEE

Catalog Part Variations Available Upon Request

GIVE US A CALL IF YOU CAN'T FIND EXACTLY WHAT YOU NEED!

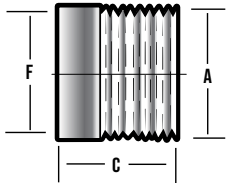

**MALE ADAPTER NIPPLE**

## STANDARD ADAPTERS - CONT.

### MALE ADAPTER NIPPLE

- 2-1/8"
- Materials: Carbon, Stainless, Aluminum, Galvanized Steel

SIZE	A-MNPT	C	E (ID)	PART NO.
2-1/8"	2"	2"	2-1/8"	MA-16

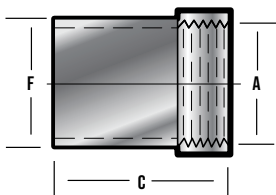

**FEMALE REDUCING ADAPTER**

### FEMALE REDUCING ADAPTER

- 2" to 2-1/2"
- Wall Thickness: 16 Gauge
- Materials: Carbon, Stainless, Aluminum, Galvanized Steel

SIZE	GAUGE	A-FNPT	C	F (OD)	PART NO.
2" to 2-1/2"	16	2"	4-1/4"	2-1/2"	FA-205

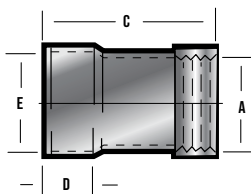

**FEMALE REDUCING ADAPTER EXPANDED**

### FEMALE REDUCING ADAPTER EXPANDED

- 2" to 2-1/2"
- Wall Thickness: 16 Gauge

SIZE	GAUGE	A-FNPT	C	D	E (ID)	PART NO.
2" to 2-1/2"	16	2"	4-1/4"	1-3/8"	2-1/2"	FA-206

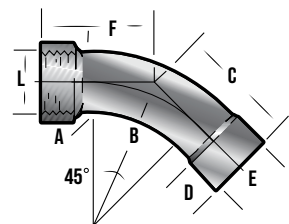

**45° FEMALE ADAPTER ELBOW**

### FEMALE REDUCING ADAPTER EXPANDED

- 2" to 2-1/2"
- Wall Thickness: 16 Gauge

SIZE	A (OD)	GAUGE	B	C	D	E (ID)	L-FNPT	PART NO.
2-1/8" to 2"	2-1/8"	16	5"	4-1/16"	1-3/8"	2-1/8"	2"	AE-2111
2-1/2" to 2"	2-1/2"	16	6"	4-1/2"	1-3/8"	2-1/2"	2"	AE-2511
2-1/2" to 2-1/2"	2-1/2"	16	6"	4-1/2"	1-3/8"	2-1/2"	2-1/2"	AE-2512

**WHEN ORDERING, PLEASE SPECIFY TYPE OF MATERIAL**

- Carbon
- Stainless
- Aluminum
- Galvanized Steel

#### KEY

MNPT = Male National Pipe Thread  
 ID = Inside Diameter  
 FNPT = Female National Pipe Thread  
 OD = Outside Diameter  
 All reference dimensions are nominal.

# METHODS OF JOINING

All reference dimensions are nominal

## SLIP COUPLINGS

Can be used for joining any two straight ends of tubing or fittings. The slip coupling is a solid sleeve that fits the OD of the joint which can then be glued, brazed, welded, or covered by shrink sleeves.

- 2-1/8" through 14" OD
- Wall Thickness: 16, 14, 12 Gauge
- Materials: Carbon, Stainless, Aluminum, Galvanized Steel

SIZE	C	D	GAUGE	PART NO.
2"	3"	2"	16	SC-203
2-1/8"	3"	2-1/8"	16	SC-213
2-1/2"	3-1/2"	2-1/2"	16	SC-253
3"	4"	3"	16	SC-303
3-1/2"	4-1/2"	3-1/2"	16	SC-353
4"	5"	4"	16	SC-403
5"	6"	5"	14	SC-503
6"	7"	6"	14	SC-603*
8"	8"	8"	14	SC-803
10"	10"	10"	12	SC-1003
12"	12"	12"	12	SC-1203
14"	14"	14"	12	SC-1403

\* JOINING METHODS ARE FOR USE IN LOW PRESSURE (UNDER 15 PSIG) SYSTEMS  
\* 6" GALVANIZED SLIP COUPLING IS 16 GAUGE. ALL OTHER MATERIALS ARE 14 GAUGE

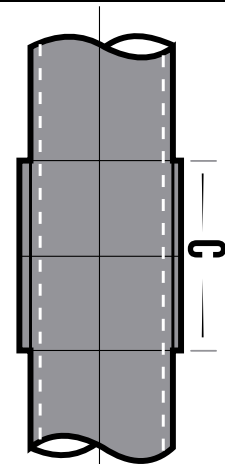

SLIP COUPLING

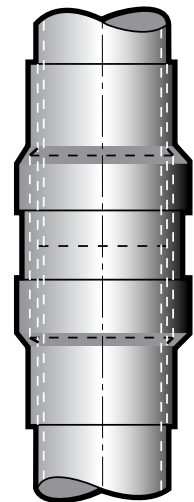

SHRINK SLEEVES

## SHRINK SLEEVES

A heat shrinkable polyolefin band that literally shrinks and encircles the connection giving it mechanical strength and a positive seal. It can be used in conjunction with a slip coupling or when using expanded fittings. Gluing, brazing and welding operations are eliminated.

FOR TUBE OD SIZE	SLEEVE LENGTH	PART NO.
2" - 2-1/8"	4"	SS-212
2-1/2" - 3"	4-1/2"	SS-300
3-1/2" - 4"	4-1/2"	SS-400
5"	4-1/2"	SS-500
6"	4-1/2"	SS-600
8"	9"	SS-800
10"	9"	SS-1000
12"	9"	SS-1200
14"	9"	SS-1400

## EXPANDED FITTINGS

This type of connection enables a straight section of tubing to slip inside the expanded end of the fitting.

The two pieces can then be "locked" together by any one of several techniques - brazing, welding, industrial adhesive or shrink sleeves. Not available in 11 gauge material. Joining methods are for use in low pressure (under 15 PSIG) systems.

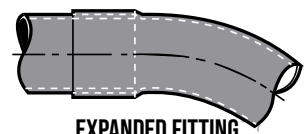

EXPANDED FITTING

### KEY

OD = Outside Diameter  
ID = Inside Diameter  
PSIG = Pounds per Square Inch Gravity  
All reference dimensions are nominal.

### WHEN ORDERING, PLEASE SPECIFY TYPE OF MATERIAL

- Carbon
- Stainless
- Aluminum
- Galvanized Steel

Catalog Part Variations Available Upon Request

GIVE US A CALL IF YOU CAN'T FIND EXACTLY WHAT YOU NEED!

# METHODS OF JOINING

©2024 H-P Products

## INSTALOCK

- Couplings are made of galvanized steel
- Standard O-ring is black nitrile
- Also offering replacement O-rings, nuts, bolts and clamps

### INSTALOK™ Specifications

- 1-1/2" OD to 4" OD
- 20% Lower cost than traditional couplings
- 30% Quicker installation
- Couplings have a unique clamping design that offers unparalleled strength and grip
- Made with Grade 5 stress relieved bolts to ensure durability
- Standard O-ring is black nitrile
- Galvanized Steel Construction

We also offer replacement O-rings, nuts, bolts and clamps

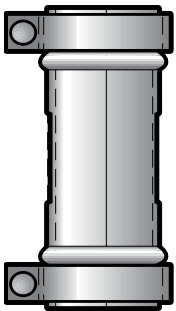

OD	NPS	O-RING	LENGTH (IN.)	PART NO.
1-1/2"	-	Black	4	CP15042B-16Z
1-1/2"	-	White	4	CP15042W-16Z
1-1/2"	-	Black	6	CP15062B-16Z
1-1/2"	-	White	6	CP15062W-16Z
1-3/4"	-	Black	4	CP17542B-16Z
1-3/4"	-	White	4	CP17542W-16Z
1-3/4"	-	Black	6	CP17562B-16Z
1-3/4"	-	White	6	CP17562W-16Z
2"	-	Black	4	CP20042B-16Z
2"	-	White	4	CP20042W-16Z
2"	-	Black	6	CP20062B-16Z
2"	-	White	6	CP20062W-16Z
2-1/8"	-	Black	4	CP21242B-16Z
2-1/8"	-	White	4	CP21242W-16Z
2-1/8"	-	Black	6	CP21262B-16Z
2-1/8"	-	White	6	CP21262W-16Z
2-1/4"	-	Black	4	CP22542B-16Z
2-1/4"	-	White	4	CP22542W-16Z
2-1/4"	-	Black	6	CP22562B-16Z
2-1/4"	-	White	6	CP22562W-16Z
2-3/8"	2"	Black	4	CP237542B-16Z
2-3/8"	2"	White	4	CP237542W-16Z
2-3/8"	2"	Black	6	CP237562B-16Z
2-3/8"	2"	White	6	CP237562W-16Z
2-3/8"	2"	Black	8	CP237582B-16Z
2-3/8"	2"	White	8	CP237582W-16Z
2-1/2"		Black	4	CP25042B-16Z
2-1/2"		White	4	CP25042W-16Z
2-1/2"		Black	6	CP25062B-16Z
2-1/2"		White	6	CP25062W-16Z
2-1/2"		Black	8	CP25082B-16Z
2-1/2"		White	8	CP25082W-16Z
2-7/8	2-1/2"	Black	4	CP287542B-16Z
2-7/8	2-1/2"	White	4	CP287542W-16Z
2-7/8	2-1/2"	Black	6	CP287562B-16Z
2-7/8	2-1/2"	White	6	CP287562W-16Z
2-7/8	2-1/2"	Black	8	CP287582B-16Z
2-7/8	2-1/2"	White	8	CP287582W-16Z



# METHODS OF JOINING

All reference dimensions are nominal

## INSTALOCK

- Couplings are made of galvanized steel
- Standard O-ring is black nitrile
- Also offering replacement O-rings, nuts, bolts and clamps

OD	NPS	O-RING	LENGTH (IN.)	PART NO.
3"	-	Black	4	CP30042B-16Z
3"	-	White	4	CP30042W-16Z
3"	-	Black	6	CP30062B-16Z
3"	-	White	6	CP30062W-16Z
3"	-	Black	8	CP30082B-16Z
3"	-	White	8	CP30082W-16Z
3-1/2"	3"	Black	4	CP35042B-16Z
3-1/2"	3"	White	4	CP35042W-16Z
3-1/2"	3"	Black	6	CP35062B-16Z
3-1/2"	3"	White	6	CP35062W-16Z
3-1/2"	3"	Black	8	CP35082B-16Z
3-1/2"	3"	White	8	CP35082W-16Z
4"	3-1/2"	Black	4	CP40042B-16Z
4"	3-1/2"	White	4	CP40042W-16Z
4"	3-1/2"	Black	6	CP40062B-16Z
4"	3-1/2"	White	6	CP40062W-16Z
4"	3-1/2"	Black	8	CP40082B-16Z
4"	3-1/2"	White	8	CP40082W-16Z

## INSTALOK DUST CAPS

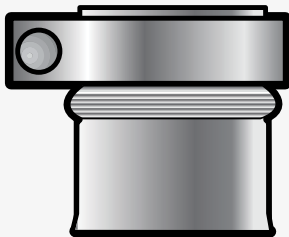

OD	NPS	O-RING	LENGTH	PART NO.
1-1/2"	-	Black	3"	DC-150-B
1-3/4"	-	Black	3"	DC-175-B
2"	-	Black	3"	DC-200-B
2-1/8"	-	Black	3"	DC-212-B
2-1/4"	-	Black	3"	DC-225-B
2-1/2"	-	Black	3"	DC-250-B
3"	-	Black	3"	DC-300-B
3-1/2"	3"	Black	3"	DC-350-B
4"	3-1/2"	Black	3"	DC-400-B

### KEY

OD = Outside Diameter  
 NPS = Nominal Pipe Size  
 All reference dimensions are nominal.

## INSTALOK™ Specifications

- 1-1/2" OD to 4" OD
- Utilizes the same unique clamping design as the INSTALOK Coupling
- Great for sealing exposed/unused material handling lines
- Non-permanent and completely reusable

**We also offer replacement O-rings, nuts, and bolts**

# METHODS OF JOINING

©2024 H-P Products

## COMPRESSION COUPLINGS

### "Our own signature coupling"

- Straight end tubing or fittings butt together within the ID of the coupling, and the joint is mechanically locked simply by tightening the bolts.
- 2-1/8" to 14" OD
- Standard Material is Galvanized Steel
- Standard Coupling includes Black Neoprene Gasket & Stainless Steel Grounding Strip.

- WE ARE ALSO CAPABLE OF STAINLESS COMPRESSION COUPLINGS
- OTHER GASKETS AVAILABLE: WHITE NITRILE, RED RUBBER, SILICONE, EPDM AND VITON
- STAINLESS STEEL GASKET PROTECTORS ARE ALSO AVAILABLE
- WE CAN FURNISH YOU WITH REPLACEMENT NUTS, BOLTS, GASKETS AND STATIC STRIPS

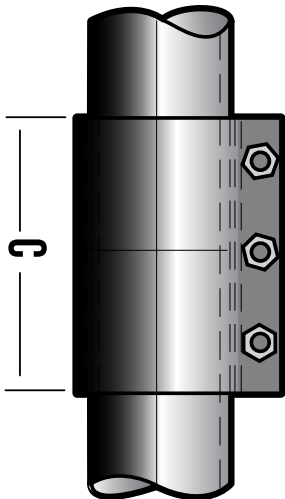

COMPRESSION  
COUPLING

### KEY

ID = Inside Diameter  
OD = Outside Diameter

All reference dimensions  
are nominal.

OD	NO. BOLT	GASKET	PROTECTOR	COUPLING LENGTH	PART NO.
2-1/8"	2	BLACK	-	4	21252B10
2-1/8"	2	BLACK	YES	4	21252B11
2-1/8"	3	BLACK	-	6	21253B10
2-1/8"	3	BLACK	YES	6	21253B11
2-1/2"	2	BLACK	-	4	25002B10
2-1/2"	2	BLACK	YES	4	25002B11
2-1/2"	3	BLACK	-	6	25003B10
2-1/2"	3	BLACK	YES	6	25003B11
2-1/2"	4	BLACK	-	8	25004B10
2-1/2"	4	BLACK	YES	8	25004B11
3"	2	BLACK	-	4	30002B10
3"	2	BLACK	YES	4	30002B11
3"	3	BLACK	-	6	30003B10
3"	3	BLACK	YES	6	30003B11
3"	4	BLACK	-	8	30004B10
3"	4	BLACK	YES	8	30004B11
3-1/2"	2	BLACK	-	4	35002B10
3-1/2"	2	BLACK	YES	4	35002B11
3-1/2"	3	BLACK	-	6	35003B10
3-1/2"	3	BLACK	YES	6	35003B11
3-1/2"	4	BLACK	-	8	35004B10
3-1/2"	4	BLACK	YES	8	35004B11
4"	2	BLACK	-	4	40002B10
4"	2	BLACK	YES	4	40002B11
4"	3	BLACK	-	6	40003B10
4"	3	BLACK	YES	6	40003B11
4"	4	BLACK	-	8	40004B10
4"	4	BLACK	YES	8	40004B11
5"	2	BLACK	-	4	50002B10
5"	2	BLACK	YES	4	50002B11
5"	3	BLACK	-	6	50003B10
5"	3	BLACK	YES	6	50003B11
5"	4	BLACK	-	8	50004B10

- FOR COUPLINGS 1-1/4" THROUGH 2-7/8" OD THE BOLT SIZE IS 1/2" X 2"
- FOR COUPLINGS 3" THROUGH 7-1/2" OD THE BOLT SIZE IS 5/8" X 2-1/4"
- FOR COUPLINGS 8" THROUGH 14" OD THE BOLT SIZE IS 3/4" X 3"
- JOINING METHODS ARE FOR USE IN LOW PRESSURE (UNDER 15 PSIG) SYSTEMS

# METHODS OF JOINING

All reference dimensions are nominal

## COMPRESSION COUPLINGS - CONT.

"Our own signature coupling"

- WE ARE ALSO CAPABLE OF STAINLESS COMPRESSION COUPLINGS
- OTHER GASKETS AVAILABLE: WHITE NITRILE, RED RUBBER, SILICONE, EPDM AND VITON
- STAINLESS STEEL GASKET PROTECTORS ARE ALSO AVAILABLE
- WE CAN FURNISH YOU WITH REPLACEMENT NUTS, BOLTS, GASKETS AND STATIC STRIPS

OD	NO. BOLT	GASKET	PROTECTOR	COUPLING LENGTH	PART NO.
5"	4	BLACK	YES	8	50004B11
6"	2	BLACK	-	4	60002B10
6"	2	BLACK	YES	4	60002B11
6"	3	BLACK	-	6	60003B10
6"	3	BLACK	YES	6	60003B11
6"	4	BLACK	-	8	60004B10
6"	4	BLACK	YES	8	60004B11
6"	5	BLACK	-	10	60005B10
6"	5	BLACK	YES	10	60005B11
8"	2	BLACK	-	6	80002B10
8"	2	BLACK	YES	6	80002B11
8"	3	BLACK	-	8	80003B10
8"	3	BLACK	YES	6	80003B11
8"	4	BLACK	-	10	80004B10
8"	4	BLACK	YES	10	80004B11
8"	5	BLACK	-	12	80005B10
8"	5	BLACK	YES	12	80005B11
10"	3	BLACK	-	8	100003B10
10"	3	BLACK	YES	8	100003B11
10"	4	BLACK	-	10	100004B10
10"	4	BLACK	YES	10	100004B11
10"	5	BLACK	-	12	100005B10
10"	5	BLACK	YES	12	100005B11
12"	3	BLACK	-	8	120003B10
12"	3	BLACK	YES	8	120003B11
12"	4	BLACK	-	10	120004B10
12"	4	BLACK	YES	10	120004B11
12"	5	BLACK	-	12	120005B10
12"	5	BLACK	YES	12	120005B11
14"	4	BLACK	-	10	140004B10
14"	4	BLACK	YES	10	140004B11
14"	5	BLACK	-	12	140005B10
14"	5	BLACK	YES	12	140005B11

- FOR COUPLINGS 1-1/4" THROUGH 2-7/8" OD THE BOLT SIZE IS 1/2" X 2"
- FOR COUPLINGS 3" THROUGH 7-1/2" OD THE BOLT SIZE IS 5/8" X 2-1/4"
- FOR COUPLINGS 8" THROUGH 14" OD THE BOLT SIZE IS 3/4" X 3"
- JOINING METHODS ARE FOR USE IN LOW PRESSURE (UNDER 15 PSIG) SYSTEMS

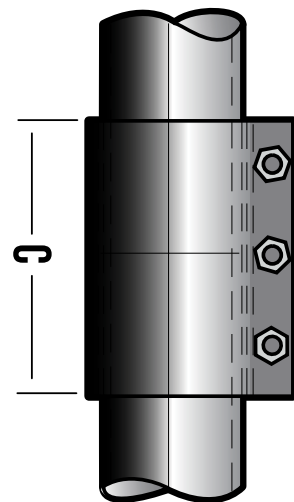

COMPRESSION  
COUPLING

### KEY

ID = Inside Diameter  
OD = Outside Diameter

All reference dimensions  
are nominal.

# METHODS OF JOINING

©2024 H-P Products

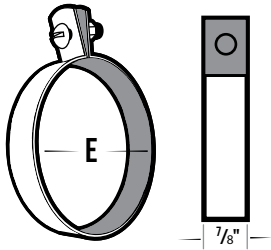

STANDARD TUBE HANGER

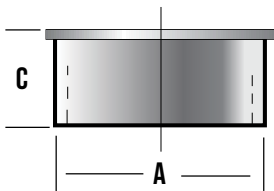

TUBE PLUG

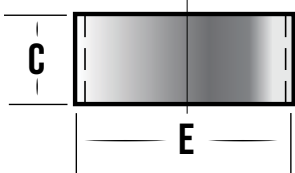

SLIP WELD RING

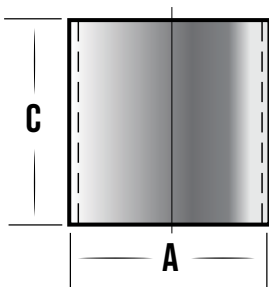

TUBE NIPPLE

## SLIP WELDING RINGS

- 8" to 14" OD
- Materials: Carbon, Stainless, Aluminum, Galvanized Steel

SIZE	C	E (ID)	GAUGE	PART NO.
8"	3"	8"	14	WR-8035
10"	3"	10"	12	WR-10035
12"	3	12"	12	WR-12035
14"	3	14"	12	WR-14035

## TUBE PLUGS

- 2-1/8" to 14" OD/ID
- Wall Thickness: 16, 14, 12 Gauge
- AVAILABLE IN 11 GAUGE

SIZE	A (OD)/ (ID)	GAUGE	C	PART NO.
2-1/8"	2-1/8" OD	16	1-3/8"	TP-210
2-1/2"	2-1/2" OD	16	1-3/8"	TP-260
3"	3" OD	16	1-3/8"	TP-310
3-1/2"	3-1/2" OD	16	1-3/8"	TP-360
4"	4" OD	16	1-3/8"	TP-410
5"	5" OD	14	1-5/8"	TP-510
6"	6" OD	14	1-5/8"	TP-610
8"	8" ID	14	1-3/4"	TP-810
10"	10" ID	12	2"	TP-1010
12"	12" ID	12	2"	TP-1210
14"	14" ID	12	2"	TP-1410

## TUBE HANGERS

- 2-1/8" to 14" ID
- Wall Thickness: 16 gauge
- Available only in Galvanized Steel

SIZE	E (ID)	GAUGE	C	PART NO.
2-1/8"	2-1/8"	16	1-3/8"	TH-212
2-1/2"	2-1/2"	16	1-3/8"	TH-250
3"	3"	16	1-3/8"	TH-300
3-1/2"	3-1/2"	16	1-3/8"	TH-350
4"	4"	16	1-3/8"	TH-400
5"	5"	16	1-5/8"	TH-500
6"	6"	16	1-5/8"	TH-600
8"	8"	16	1-3/4"	TH-800
10"	10"	16	2"	TH-1000
12"	12"	16	2"	TH-1200
14"	14"	16	2"	TH-1400

## TUBE NIPPLES

- 2-1/8" to 14" OD
- Wall Thickness: 16, 14, 12 Gauge
- AVAILABLE IN 11 GAUGE

SIZE	A (OD)	GAUGE	C	PART NO.
2-1/8"	2-1/8"	16	2-1/2"	TN-211
2-1/2"	2-1/2"	16	2-1/2"	TN-261
3"	3"	16	2-1/2"	TN-311
3-1/2"	3-1/2"	16	2-1/2"	TN-361
4"	4"	16	2-1/2"	TN-411
5"	5"	14	3"	TN-511
6"	6"	14	3"	TN-611
8"	8"	14	4"	TN-811
10"	10"	12	5"	TN-1011
12"	12"	12	6"	TN-1211
14"	14"	12	7"	TN-1411

WHEN ORDERING,  
PLEASE SPECIFY  
TYPE OF MATERIAL

- Carbon
- Stainless
- Aluminum
- Galvanized Steel

### KEY

ID = Inside Diameter  
OD = Outside Diameter  
All reference dimensions are nominal.

# ACCESSORIES

All reference dimensions are nominal

## INSTALLATION COMPONENTS

H-P Products, Inc. gives you everything you need to get your system up and running, all in one complete installation package. If you're searching for a particular installation component, we'll be glad to help you find whatever you're looking for. Our "one-stop-shopping" will help you lower your inventory costs and spend less time looking for parts. And, when it's time for installation, you'll have all the components you need on-the-spot.

DESCRIPTION	SIZE	MATERIAL	PKGD	PRODUCT ID
<b>Anchor, Hilti®</b>	3/8" x 1-9/16" (Length)	Zinc	50 pc	ANC-0380
<b>Bolt Anchor</b>	3/8" x 3-3/4" (Overall Length)	Zinc	100 pc.	ANC-0381
Includes Washer and Hex Nut	1-1/8" Thread Length			
<i>Features: Comprehensive performance testing in concrete, lightweight concrete, and grout-filled block base materials. Can be installed in a bottomless hole. Anchor size is same as hole size for easy installation. Hilti® Kwik Bolt II Stud Anchor System.</i>				
<b>Hex Head Cap Screw</b> "More Length When You Need It"	3/8" x 1-1/4" (Length)	Zinc	50 pc.	HCS-0381
<b>Hex Nut</b>	3/8"	Zinc	50 pc.	HXN-0380
<b>Flat Washer</b>	3/8"	Zinc	50 pc.	FW-0380
<b>Split Lock Washer</b>	3/8"	Zinc	50 pc.	LKW-0380
<b>Threaded Rod</b>	3/8" x 6' (Length)	Zinc	50 pc.	ATR-100
<b>Eye Nut</b> , Maximum Allowable Load is 610 lbs. "Works Great With our Tube Hangers"	3/8" Tapped Hole	Malleable Iron - Plain.	50 pc.	EN-0380
<b>Coupler Nut</b>	3/8" x 1-3/4" (Length)	Zinc	each	CN-0380
<b>Beam Clamp</b> with Zinc Set Screw and Lock Nut.	3/8" Tapped Hole	Malleable Iron - Galv.	each	BC-037T
Maximum Allowable Load, in top or bottom position, is 550 lbs.				
<b>Beam Clamp</b> with Set Screw and Lock Nut.	3/8" Tapped Hole	Malleable Iron - Plain	50 pc.	BC-100
Maximum Allowable Load, in top position, is 500 lbs.; in bottom position, 250 lbs. "The Cost-Effective Solution When You Don't Need Our Heavy-Duty Beam Clamp (BC-037T)"				
<b>Channel Nut, without spring</b>	3/8"	Zinc	each	CHN-0380
<b>Saddlenut Assembly</b> "Replaces Square Washer Plate and a Channel Nut Combination"		Zinc	50	SN-0380
<b>Slotted Strut, 14 Gauge</b>	13/16"(D) x 1-5/8", 10' Length	Zinc	each	UN-100
<b>Slotted Strut, 14 Gauge</b>	1-5/8"(D) x 1-5/8", 10' Length	Zinc	each	UN-201
<i>"An Economical Alternative When You Don't Require Our Heavy-Duty Strut (UN-202)"</i>				
<b>Slotted Strut, 12 Gauge</b>	1-5/8"(D) x 1-5/8", 10' Length	Zinc	each	UN-202

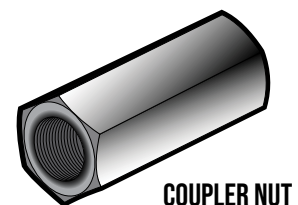
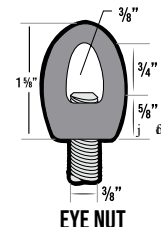
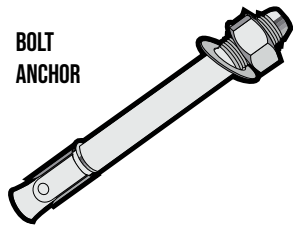
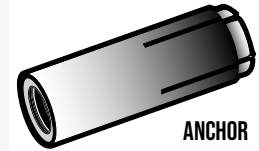
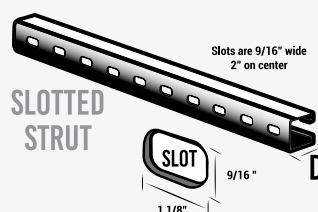
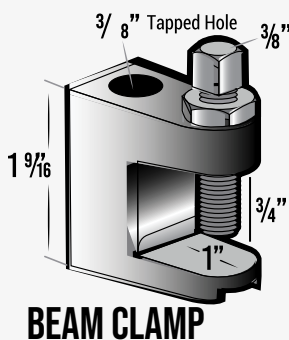

Catalog Part Variations Available Upon Request

**GIVE US A CALL IF YOU CAN'T FIND EXACTLY WHAT YOU NEED!**

# ACCESSORIES

©2024 H-P Products



**CHANNEL NUT**

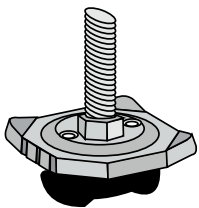

**SADDLE NUT ASSEMBLY**

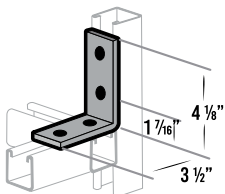

**90° STRUT BRACKET**  
2 HOLES X 2 HOLES

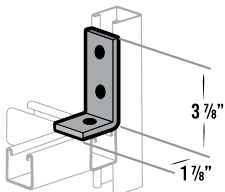

**90° STRUT BRACKET**  
2 HOLES X 1 HOLES

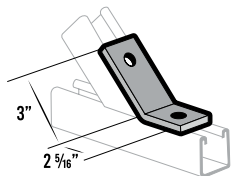

**45° STRUT BRACKET**  
1 HOLES X 1 HOLES

## INSTALLATION COMPONENTS - CONT.

DESCRIPTION	SIZE	MATERIAL	PKGD	PRODUCT ID
<b>90° Strut Bracket</b>	2 x 2, 9/16" Holes	Zinc	each	BRKT-0900
<b>90° Strut Bracket</b>	2 x 1, 9/16" Holes	Zinc	each	BRKT-0901
<b>45° Strut Bracket</b>	9/16" Holes	Zinc	each	BRKT-0450
<b>Square Washer Plate</b>	7/16" Hole for 3/8" Bolt Size	Zinc	100 pc.	SQW-0380
<b>Tube Hanger, includes Bolt and Nut</b>	For 1-1/2" OD Tube	Zinc	each	TH-150
<b>Tube Hanger, includes Bolt and Nut</b>	For 2" OD Tube	Zinc	each	TH-200
<b>Tube Hanger, includes Bolt and Nut</b>	For 2-1/8" and 2-1/4" OD Tube	Zinc	each	TH-212
<b>Tube Hanger, includes Bolt and Nut</b>	For 2-1/2" OD Tube	Zinc	each	TH-250
<b>Tube Hanger, includes Bolt and Nut</b>	For 3" OD Tube	Zinc	each	TH-300
<b>Tube Hanger, includes Bolt and Nut</b>	For 3-1/2" OD Tube	Zinc	each	TH-350
<b>Tube Hanger, includes Bolt and Nut</b>	For 4" OD Tube	Zinc	each	TH-400
<b>Tube Hanger, includes Bolt and Nut</b>	For 4-1/2" OD Tube	Zinc	each	TH-450
<b>Tube Hanger, includes Bolt and Nut</b>	For 5" OD Tube	Zinc	each	TH-500
<b>Tube Hanger, includes Bolt and Nut</b>	For 6" OD Tube	Zinc	each	TH-600
<b>Tube Hanger, includes Bolt and Nut</b>	For 8" OD Tube	Zinc	each	TH-800
<b>Tube Hanger, includes Bolt and Nut</b>	For 10" OD Tube	Zinc	each	TH-1000
<b>Tube Hanger, includes Bolt and Nut</b>	For 12" OD Tube	Zinc	each	TH-1200
<b>Tube Hanger, includes Bolt and Nut</b>	For 14" OD Tube	Zinc	each	TH-1400
<b>Pipe Clamp, includes Slotted Hex Head Screw and Nut, Design Load 800 lbs.</b>	For 1-1/2" Pipe Size	Zinc	4 pc.	PCL-150
<b>Pipe Clamp, includes Slotted Hex Head Screw and Nut, Design Load 800 lbs.</b>	For 2" Pipe Size	Zinc	4 pc.	PCL-200
<b>Pipe Clamp, includes Slotted Hex Head Screw and Nut, Design Load 800 lbs.</b>	For 2-1/2" Pipe Size	Zinc	4 pc.	PCL-250
<b>Pipe Clamp, includes Slotted Hex Head Screw and Nut, Design Load 800 lbs.</b>	For 3" Pipe Size	Zinc	4 pc.	TCL-350*
<b>Pipe Clamp, includes Slotted Hex Head Screw and Nut, Design Load 1000 lbs.</b>	For 3-1/2" Pipe Size	Zinc	4 pc.	TCL-400*
<b>Pipe Clamp, includes Slotted Hex Head Screw and Nut, Design Load 1000 lbs.</b>	For 4" Pipe Size	Zinc	4 pc.	TCL-450*
<b>Pipe Clamp, includes Slotted Hex Head Screw and Nut, Design Load 1000 lbs.</b>	For 5" Pipe Size	Zinc	4 pc.	PCL-500
<b>Pipe Clamp, includes Slotted Hex Head Screw and Nut, Design Load 1000 lbs.</b>	For 6" Pipe Size	Zinc	4 pc.	PCL-600
<b>Pipe Clamp, includes Slotted Hex Head Screw and Nut, Design Load 1000 lbs.</b>	For 8" Pipe Size	Zinc	4 pc.	PCL-800

\* Tube Clamp also fits this pipe size.

### KEY

Zinc = Galvanized Carbon Steel  
OD = Outside Diameter  
All reference dimensions are nominal.

# ACCESSORIES

All reference dimensions are nominal

## INSTALLATION COMPONENTS - CONT.

DESCRIPTION	SIZE	MATERIAL	PKGD	PRODUCT ID
<b>Tube Clamp</b> , includes Slotted Hex Head Screw and Nut, Design Load 600 lbs.	For 1-1/2" OD Tube	Zinc	4 pc.	TCL-150
<b>Tube Clamp</b> , includes Slotted Hex Head Screw and Nut, Design Load 800 lbs.	For 2" OD Tube	Zinc	4 pc.	TCL-200
<b>Tube Clamp</b> , includes Slotted Hex Head Screw and Nut, Design Load 800 lbs.	For 2-1/8" OD Tube	Zinc	4 pc.	TCL-212
<b>Tube Clamp</b> , includes Slotted Hex Head Screw and Nut, Design Load 800 lbs.	For 2-1/4" OD Tube	Zinc	4 pc.	TCL-225
<b>Tube Clamp</b> , includes Slotted Hex Head Screw and Nut, Design Load 800 lbs.	For 2-1/2" OD Tube	Zinc	4 pc.	TCL-250
<b>Tube Clamp</b> , includes Slotted Hex Head Screw and Nut, Design Load 800 lbs.	For 3" OD Tube	Zinc	4 pc.	TCL-300
<b>Tube Clamp</b> , includes Slotted Hex Head Screw and Nut, Design Load 800 lbs.	For 3-1/2" OD Tube	Zinc	4 pc.	TCL-350
<b>Tube Clamp</b> , includes Slotted Hex Head Screw and Nut, Design Load 1000 lbs.	For 4" OD Tube	Zinc	4 pc.	TCL-400
<b>Tube Clamp</b> , includes Slotted Hex Head Screw and Nut, Design Load 1000 lbs.	For 4-1/2" OD Tube	Zinc	4 pc.	TCL-450
<b>Tube Clamp</b> , includes Slotted Hex Head Screw and Nut, Design Load 1000 lbs.	For 5" OD Tube	Zinc	4 pc.	TCL-500
<b>Tube Clamp</b> , includes Slotted Hex Head Screw and Nut, Design Load 1000 lbs.	For 6" OD Tube	Zinc	4 pc.	TCL-600
<b>Tube Clamp</b> , includes Slotted Hex Head Screw and Nut, Design Load 1000 lbs. ** 2 piece package	For 8" OD Tube	Zinc	2 pc.	TCL-800**
<b>Firestop Sealant</b>	10.5-oz. Tube	-	each	FST-100
<b>Cleaner</b>	Quart	-	each	2868
<b>Metal Sealant</b>	Quart Can	-	each	2084-QT

An aluminum-colored, medium viscosity, synthetic rubber sealant with excellent adhesion to many metal, glass, wood and other surfaces.

Features: Adheres to metal, wood and glass. Seals metal to glass in windows and doors. Resists weather, water, oil and gasoline. Solids wt. approx. 46%, Flash Point (closed cup) 0° F, heavy liquid consistency, aluminum color (dry), brush or flow application. Drying time is 24 hours (1/8" dia. bead), service temp. range of -30° to 200° F. 3M Scotch-Seal™ 2084 Metal Sealant repackaged by H-P Products, Inc.

### NOTE:

Tube Clamps are now available in 50 packs! To order, simply add -50 to the end of the Part Number!

### KEY

Zinc = Galvanized Carbon Steel  
OD = Outside Diameter  
All reference dimensions are nominal.

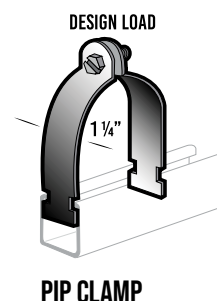

PIP CLAMP

## SPECIAL SERVICES

### SPECIAL REQUESTS & CATALOG PART VARIATIONS

If our standard catalog items don't meet your needs, please contact us at 1-800-860-TUBE(8823) for assistance with making alterations of standard parts, or to fabricate a custom part to your exact specification. We have extensive custom tube fabrication services available to help you meet your required specifications.

#### SHOT PEENING



### DIRECTIONAL SHOT PEENING

Transported resin pellets tend to degrade when contact is made with internal tube or pipe surfaces. The velocity of the pellets result in friction and heat, which can cause them to smear within tubing and elbows. When these smeared pellets are dislodged from the interior of tube or pipe they can easily clog material lines and hoppers. The result is potential lost production time.

Directional shot peening produces a dimpling effect that has been found to reduce the formation of fines, fluff, and streamers within pneumatic conveying systems. The directional surface finish has the added benefit of hardening the tube or pipe, extending its life over non-treated surfaces. Shot peening has been reported to result in one third the fines or angel hair typical in non-treated systems.

#### PORCELAIN LINING

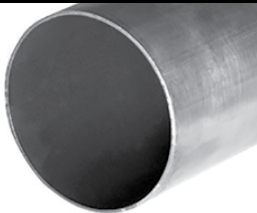

### PORCELAIN LINING

Porcelain lining is used due to its resistance to corrosive attack, atmospheric pollution, extreme weather conditions, and abrasion. In these extreme environments, standard steel tube, pipe, and elbows can have a limited service life.

Porcelain enamel is a glassy compound that is adhered to the inside diameter of tube or pipe. This compound is applied as a liquid slurry to the interior of carbon or stainless steel. When baked, the result is a glassy interior surface that is rated at 6 to 7 on the Moh's scale of hardness; diamonds are the hardest at a rating of 10. The surface will easily resist scratching from a steel blade.

Porcelain lining is available in single or double coat, and the thickness of the coating is checked before shipment. Single coating is .004-.007" thick, and double coating is .008-.012" thick. Tube or pipe up to 10' in length can be porcelain lined.

#### CERAMIC COATING



### CERAMIC COATING

In extreme industrial environments where abrasive materials are pneumatically conveyed, unprotected elbows can wear out in just a few weeks.

Ceramic coating is composed of a proprietary matrix of high alumina ceramic beads and fillers. This matrix is then covered in a fiberglass wrap that adds structure and additional wear resistance. Once the original substrate wears through, the ceramic coating adds additional service life. Coating can be added to all materials offered and in almost any part configuration.

#### TERMINOLOGY

CLR	Center Line Radius
ERW	Electric Resistance Welded
FNPT	Female National Pipe Thread
ID	Inside Diameter
MNPT	Male National Pipe Thread
NPS	Nominal Pipe Size
OD	Outside Diameter
SCH	Schedule

#### DELIVERY & PRICING

Fast fulfillment is available by freight or delivery service on a wide selection of in-stock products. We'll also make a diligent effort to meet emergency requirements for non-stock items.

All prices are FOB factory, Louisville, Ohio  
Prices are in U.S. dollars

Prices and specifications are subject to change without notice, and without obligation. All material is invoiced at the price in effect at time of shipment. All prices and discounts are based on one shipment to one destination. Please see current price list for pricing.



# NOTES

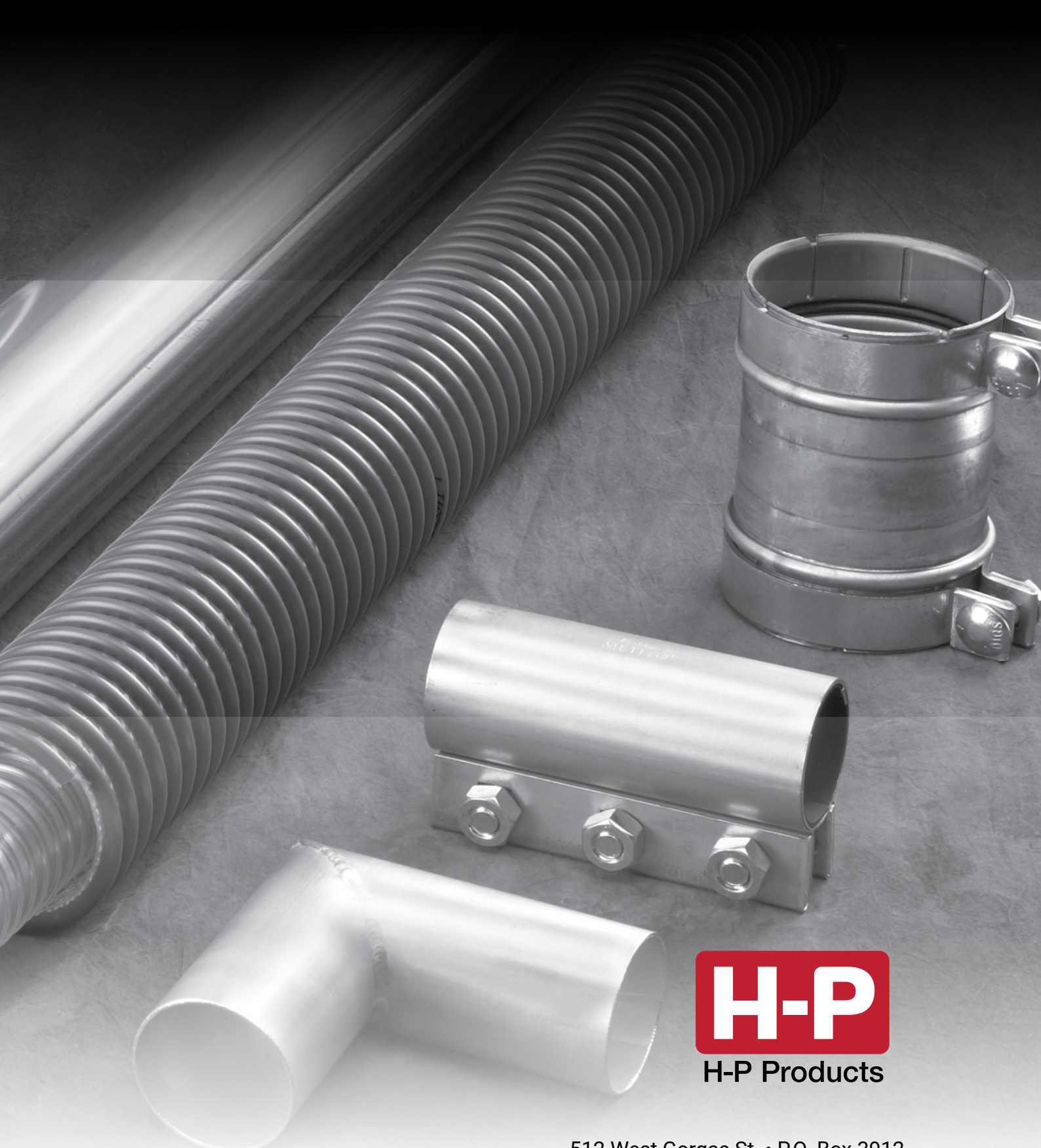

512 West Gorgas St. • P.O. Box 3912  
Louisville, Ohio 44641-312

**1.800.860.TUBE (8823)**  
Fax: 330.875.7155  
[www.H-PPRODUCTS.com](http://www.H-PPRODUCTS.com)

S-120-0062  
©2024 H-P Products